

200 METER

- 0
- 1
- 2
- 3
- 4
- 5
- 10
- 15
- 20
- 25
- 30

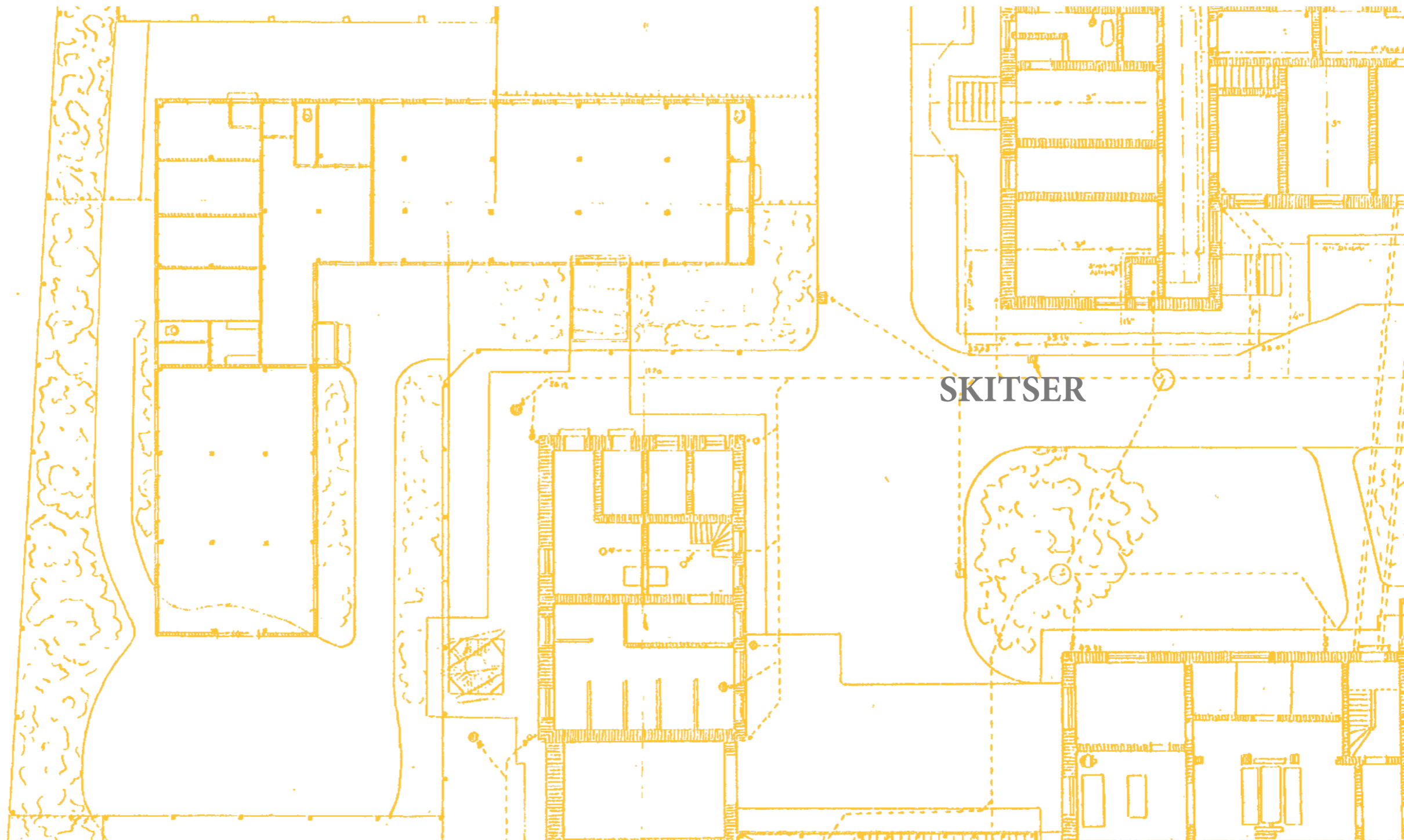

*En historisk mulighed - Udviklingsplan for Frederiksberg Hospital*

*Afgangprojekt juni 2018*

*Rasmus Boysen Feddersen, stud5300*

*Tim Bruun, stud5337*

*Det Kongelige Danske Kunstakademis Skoler  
for Arkitektur, Design og Konservering*

*Bosætning, Økologi og Tektonik*

*Vejledere:*

*Anne Beim*

*Nathan Romero Muelas*

# INDHOLD

---

MODELSTUDIER	03
STRATEGI	21
NEDSLAG	27

# MODELSTUDIER

01



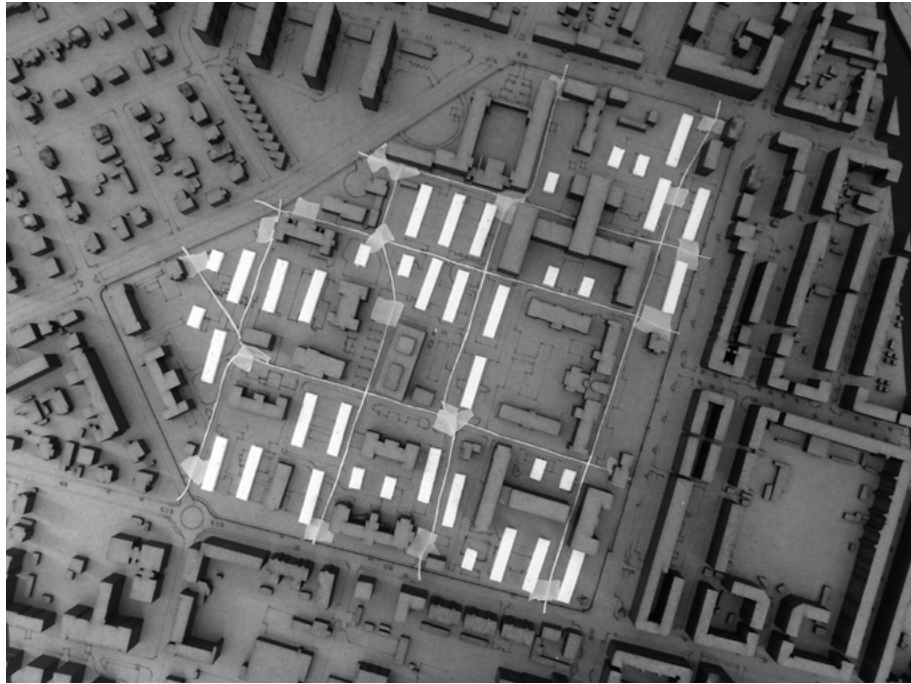

STÆNGER 01

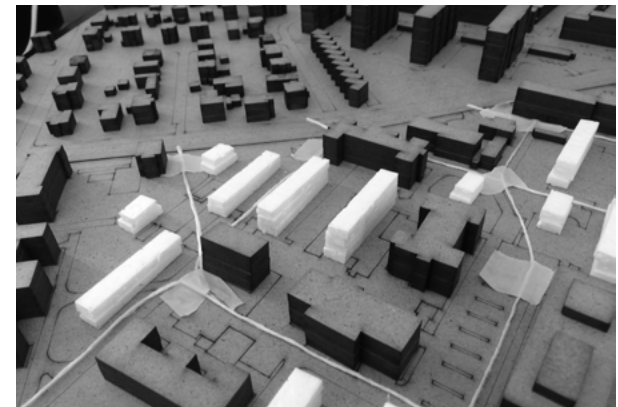
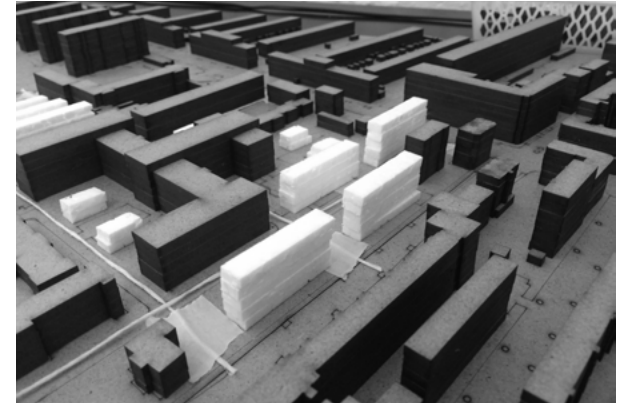

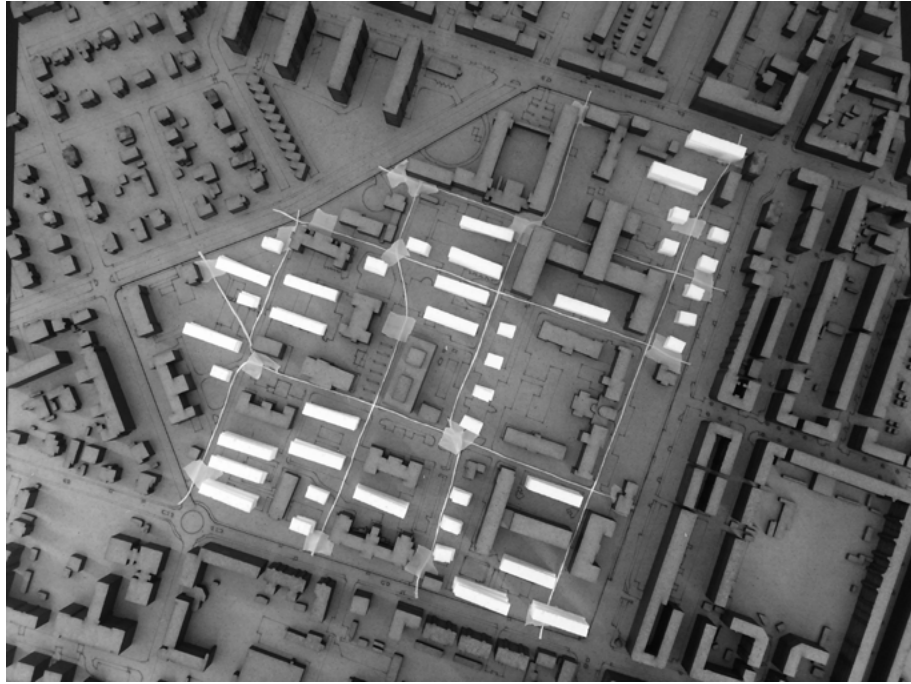

STÆNGER 02

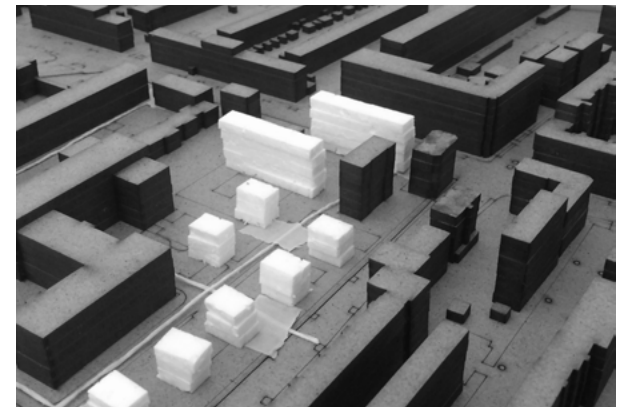
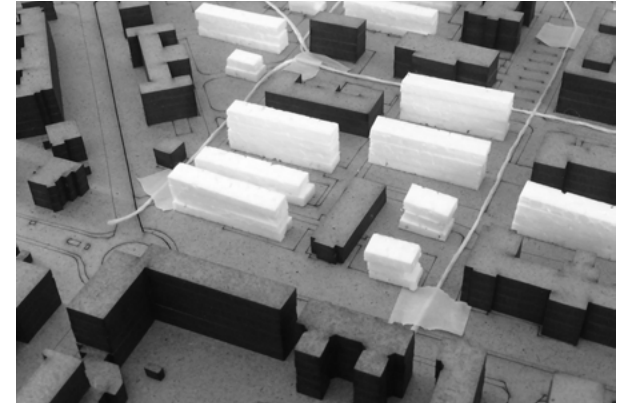

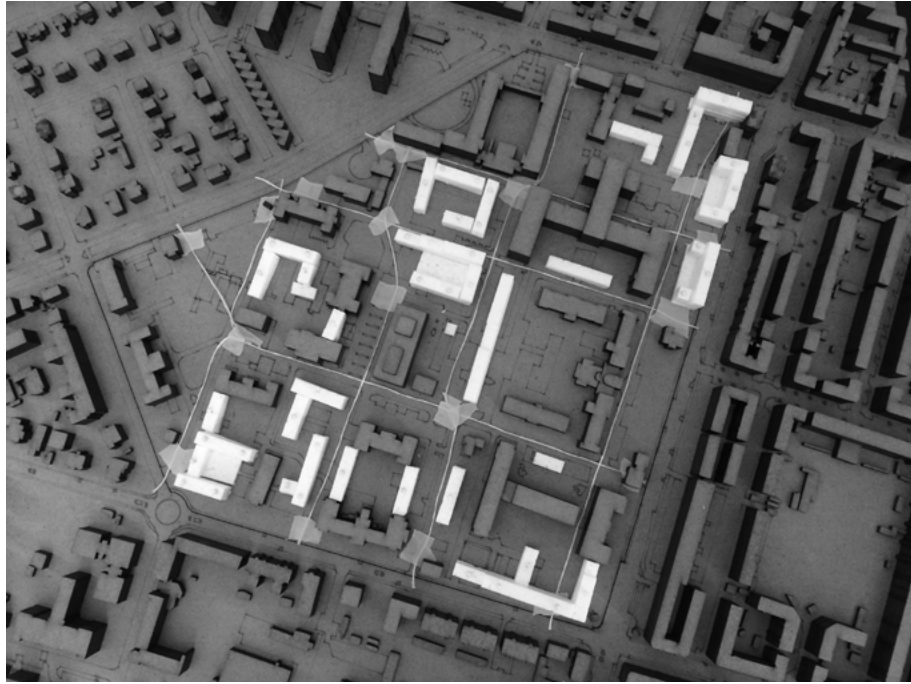

TILPASNING 01

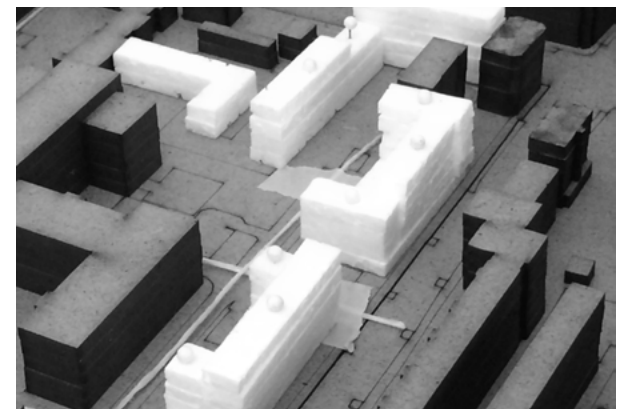
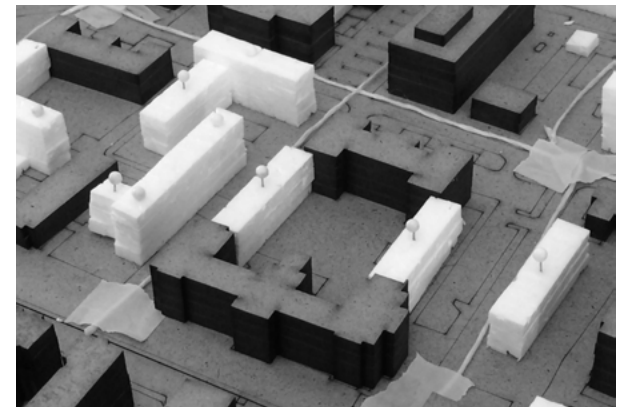
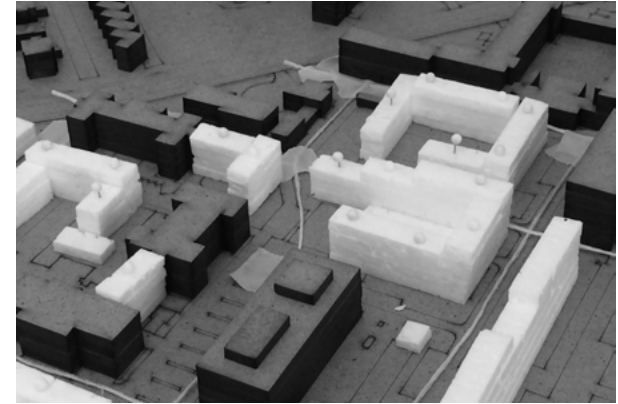

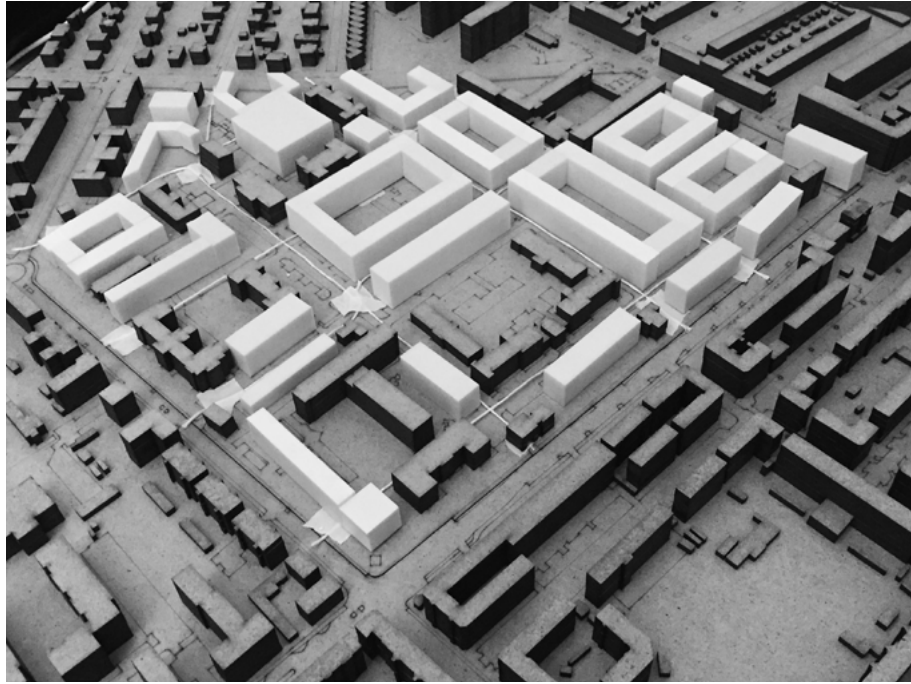

KARRE

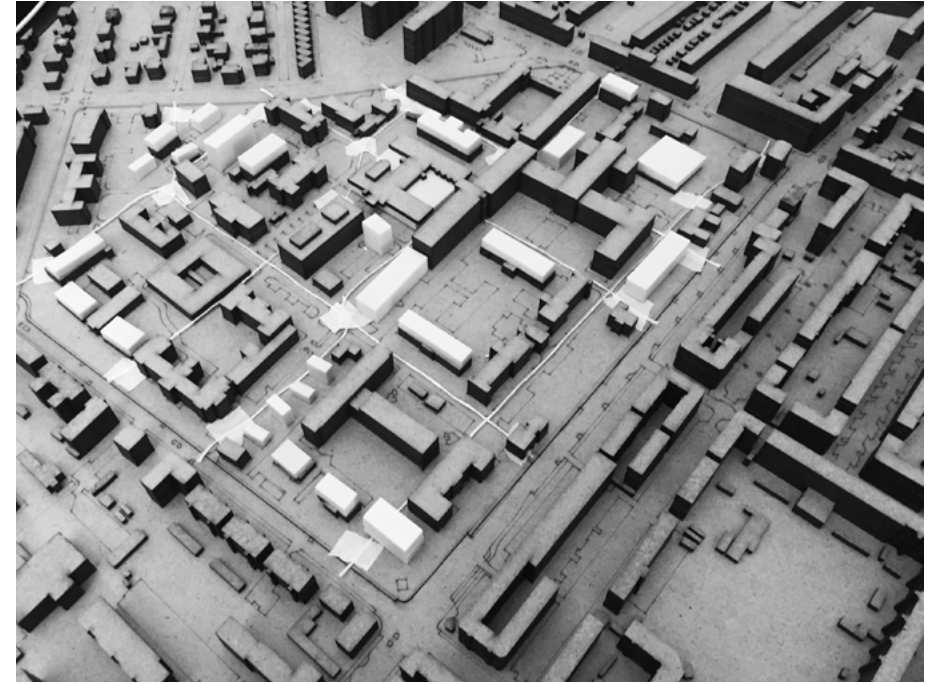

INFILL 01

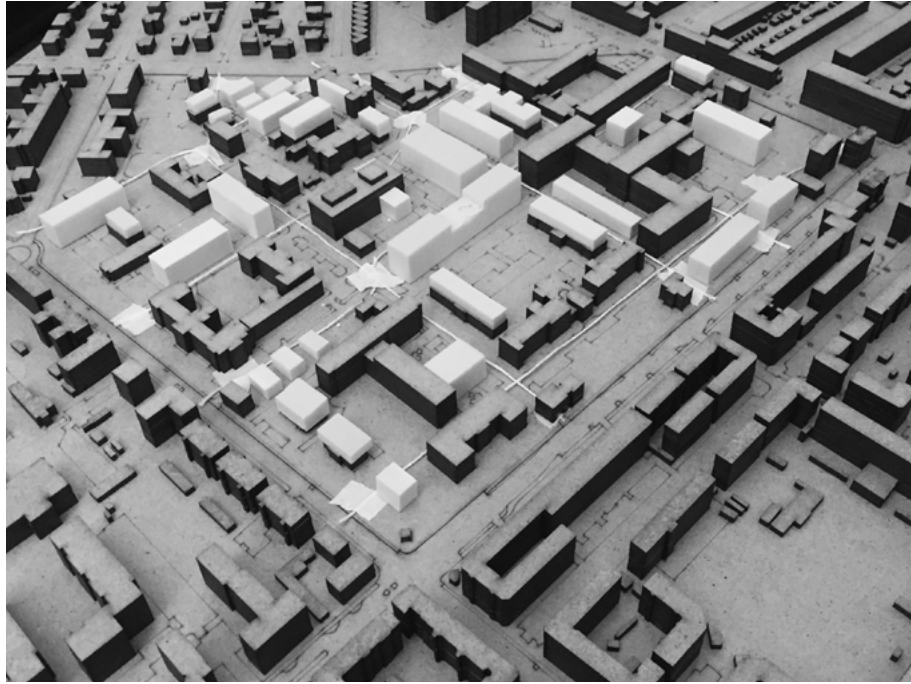

INFILL 02

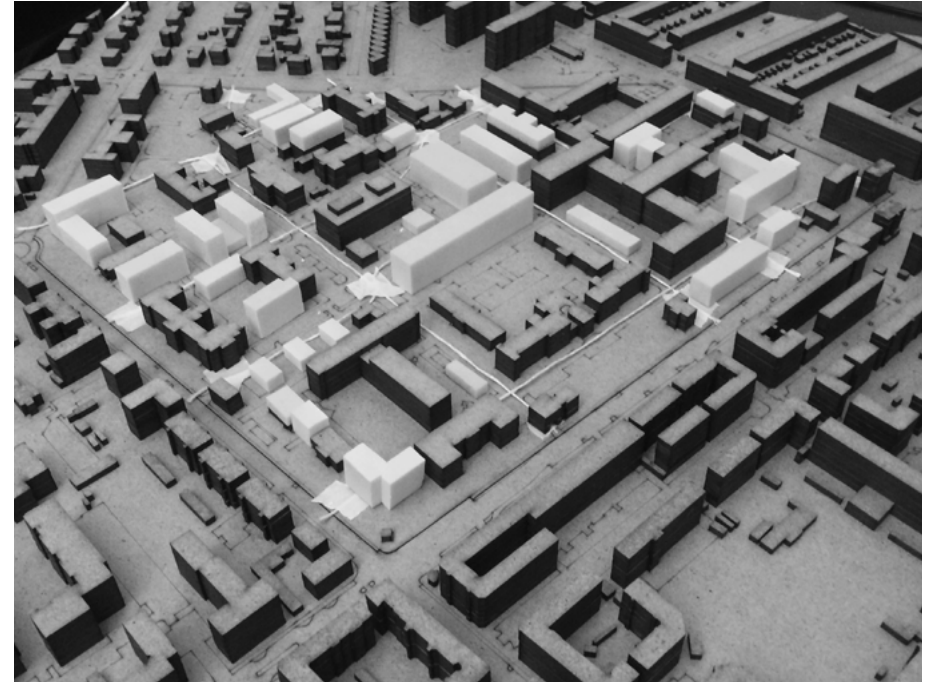

INFILL 03

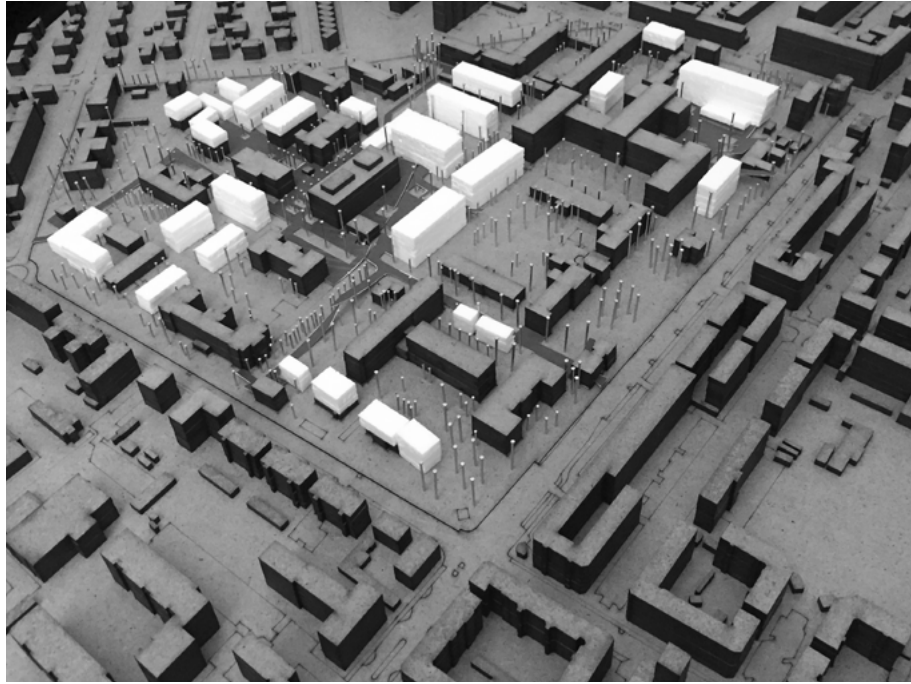

AS FOUND 01

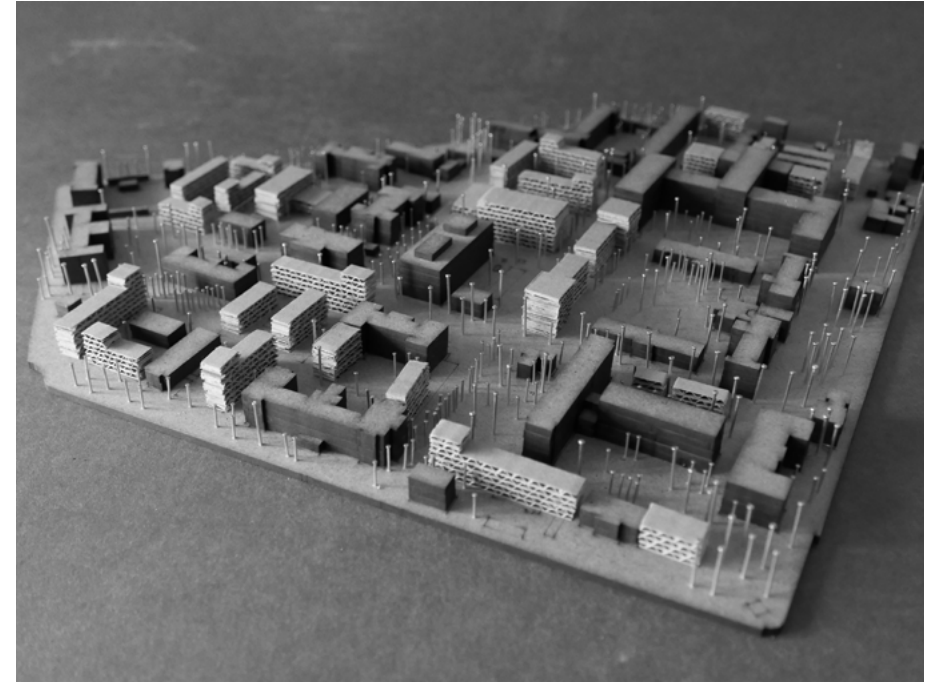

KLYNGER





*Inden i*

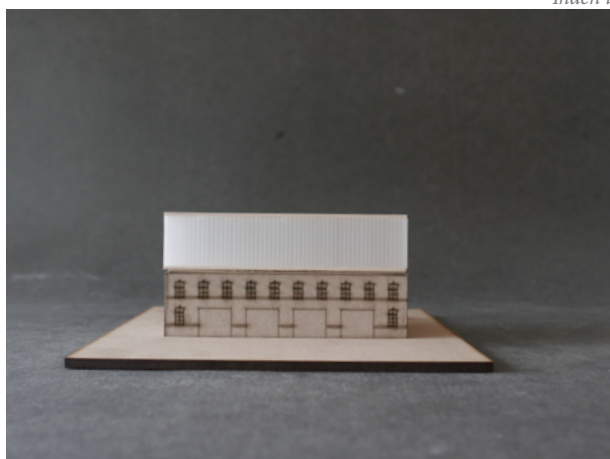

*Oven på*

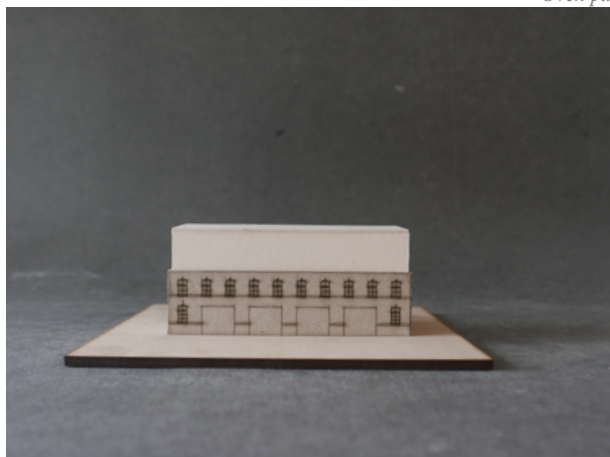

*Op ad*



*Filigran*

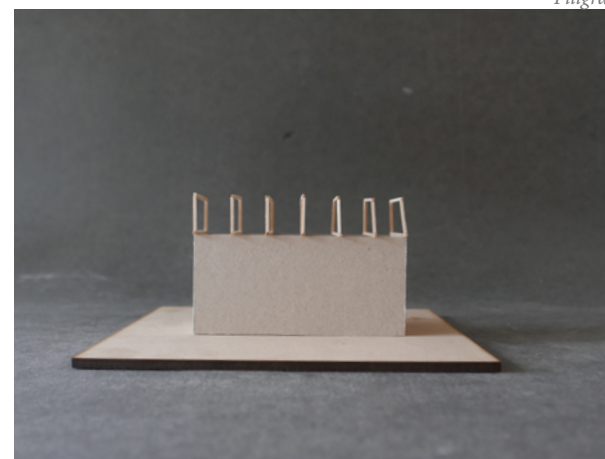

*Massiv*

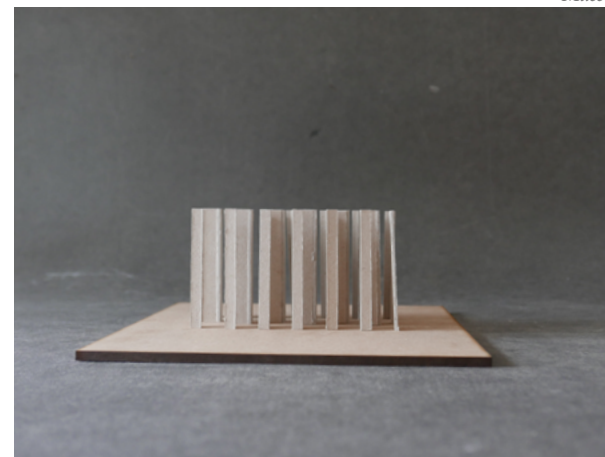

*Skiver*

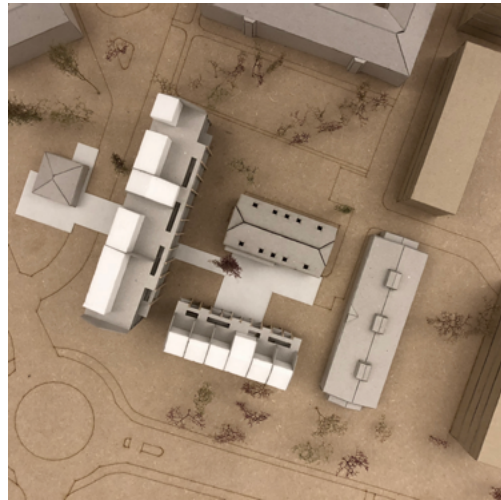



# STRATEGI

02

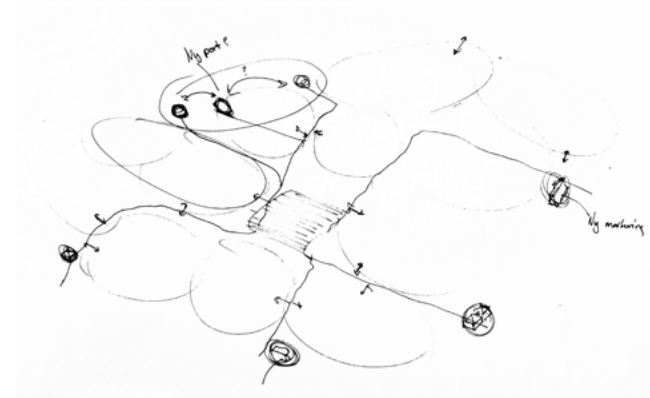
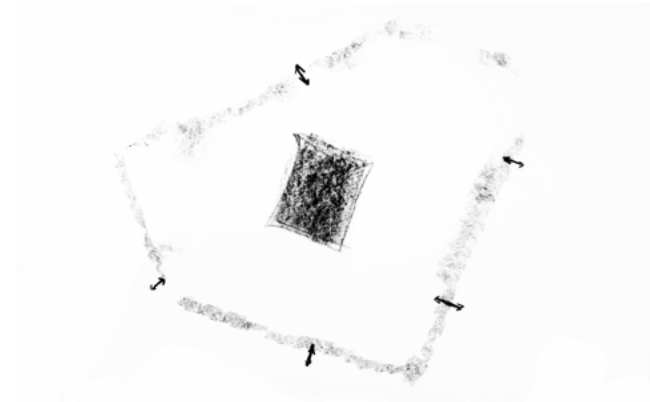
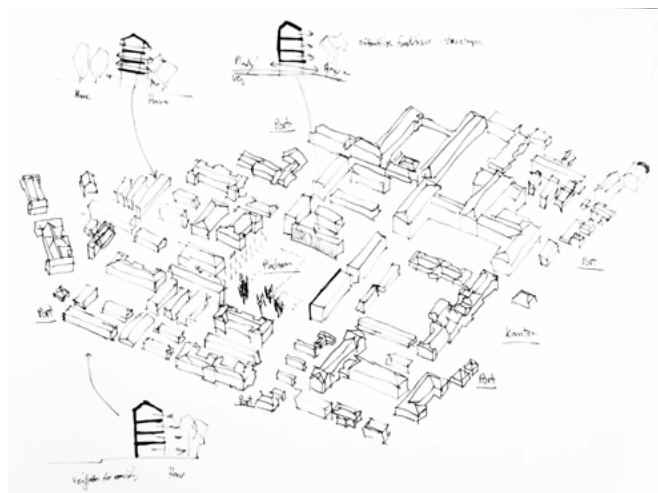
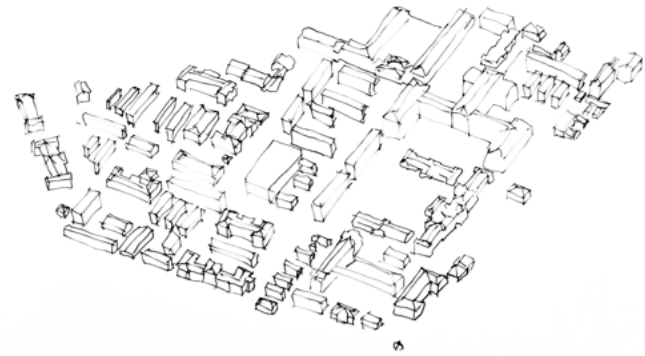

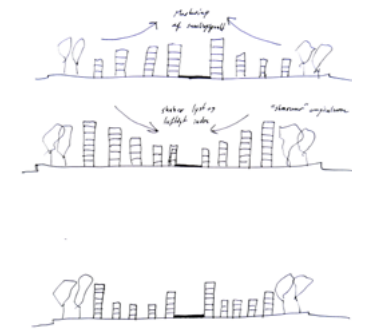
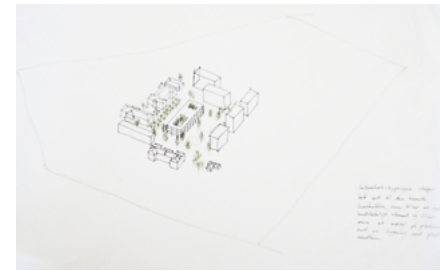

# NEDSLAG

03

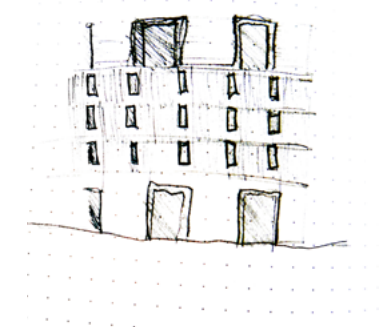
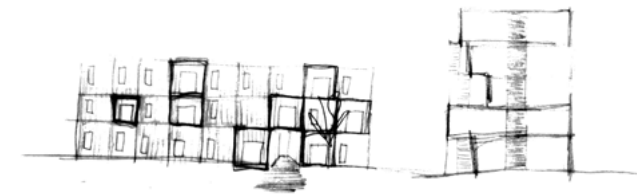
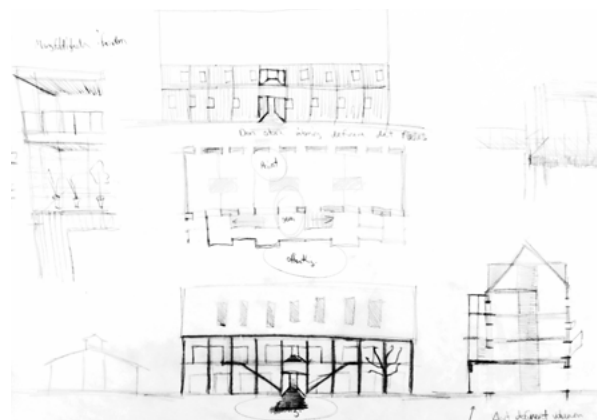
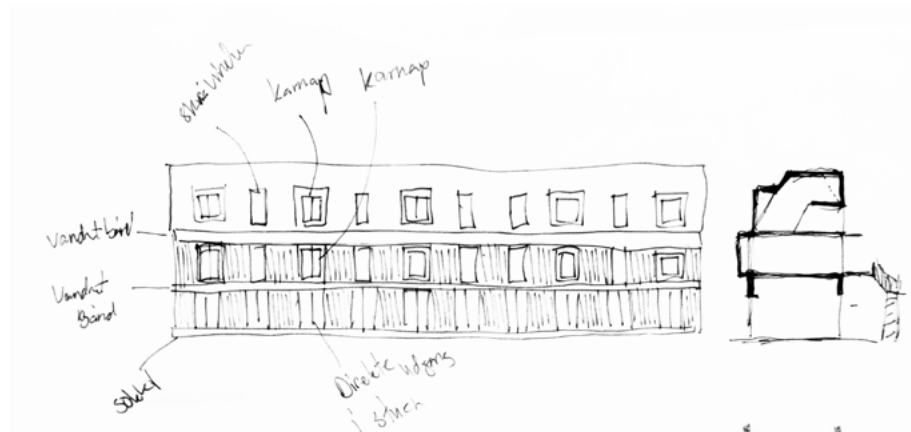

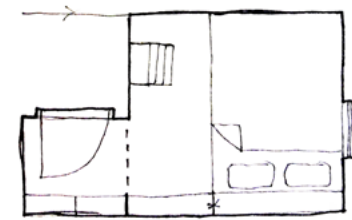
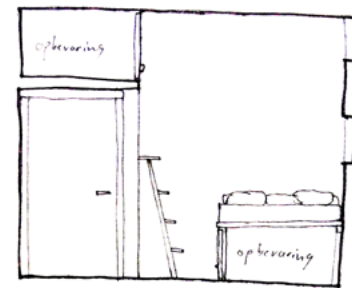
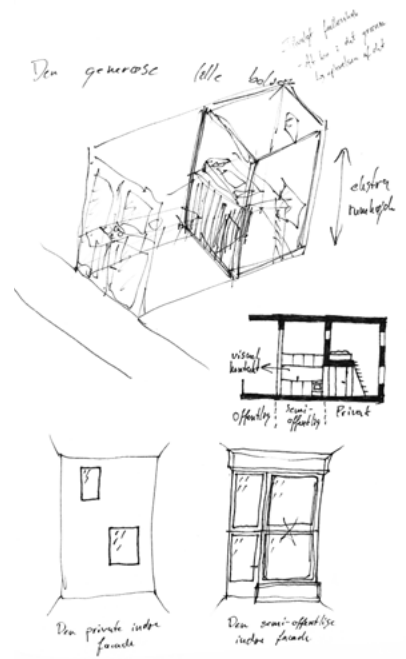
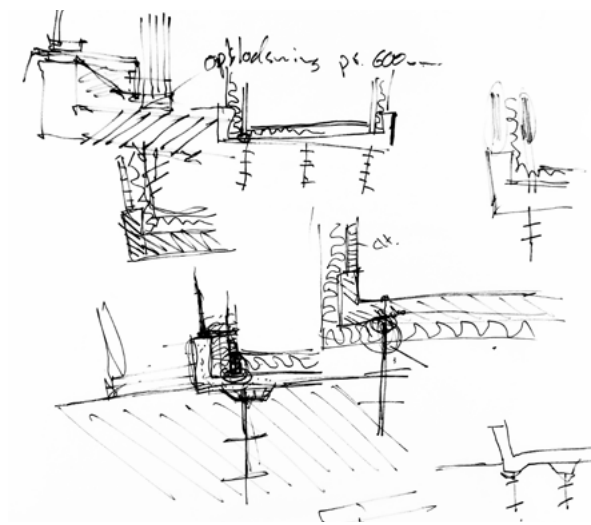
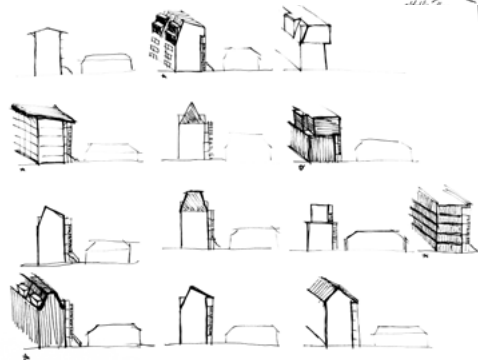
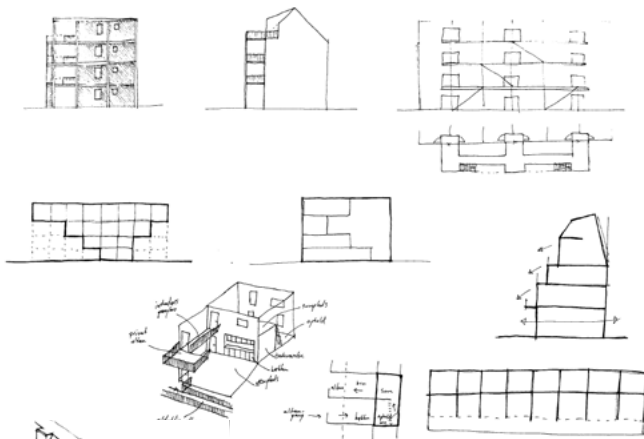
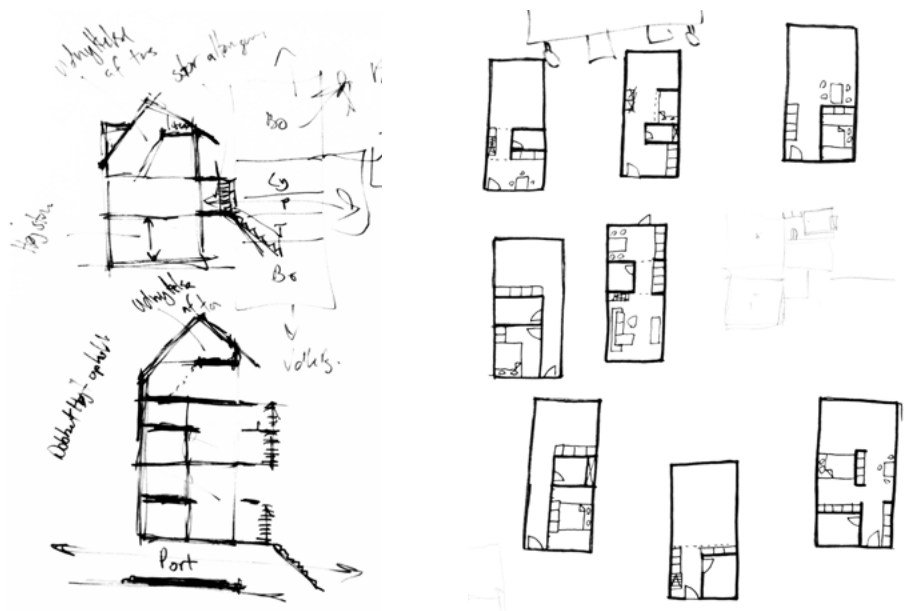



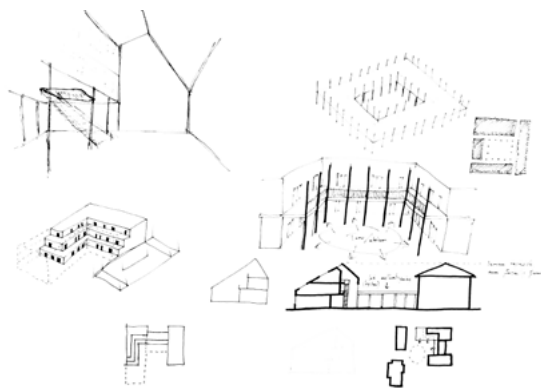

En klippe - vilgræn



Bygges tekniske løsninger

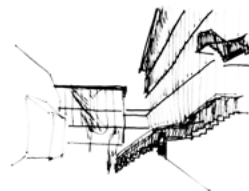

skalafælbild

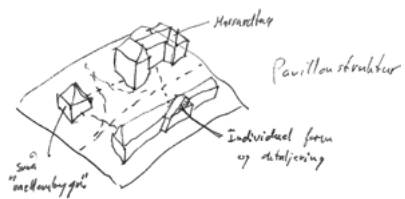
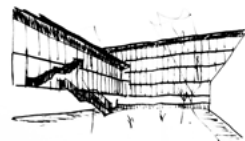

Heranlæg

Pavillonstruktur

Individual form og detaljering

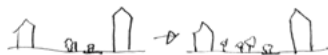
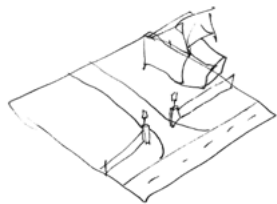
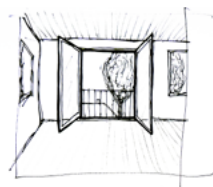

En klippe - massiv

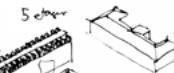

5 etager  
3 etager  
Fritstående angår  
Trappehuset



1:50

Hvad er delene bygget af?

Hvordan er det bygget?

Limtræ, CLT, stål

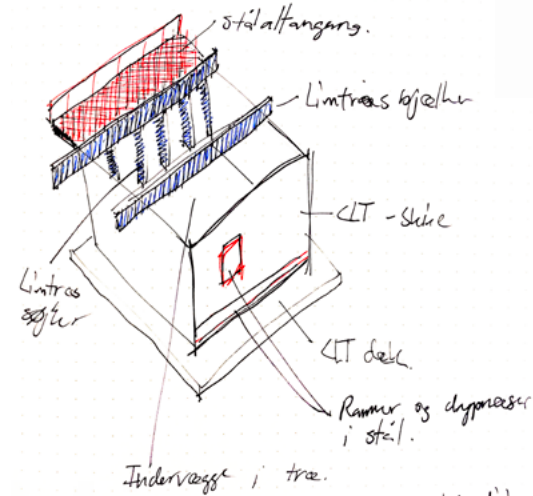
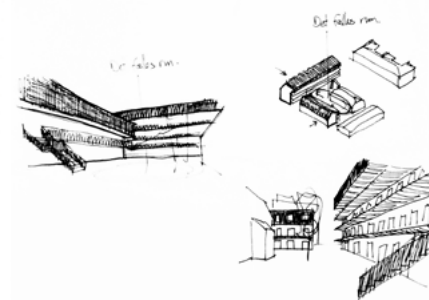

stålafgang.

Limtræs bjælker

CLT - Skive

Limtræs søjler

CLT dæk

Rammer og dygnestær i stål.

Indervægge i træ.



Ext. Samlet. Massivitet

Selvstændigt tag.  
Ramm. Stål.  
Skakel/fuldmægt.

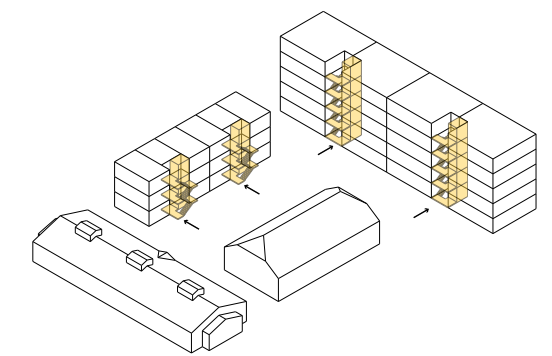
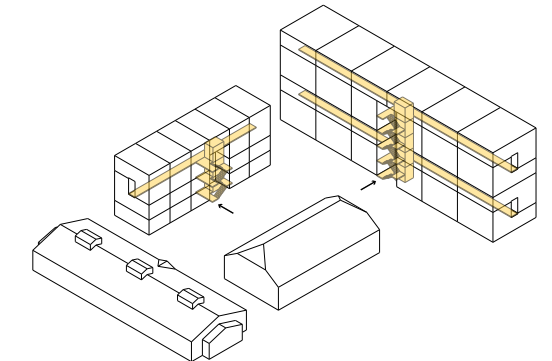
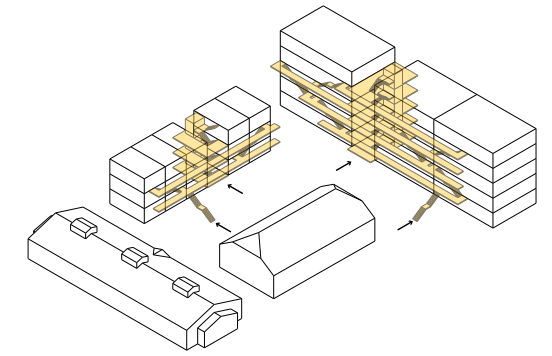
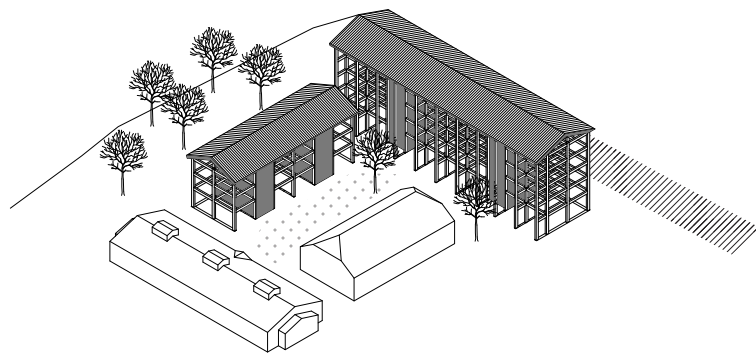
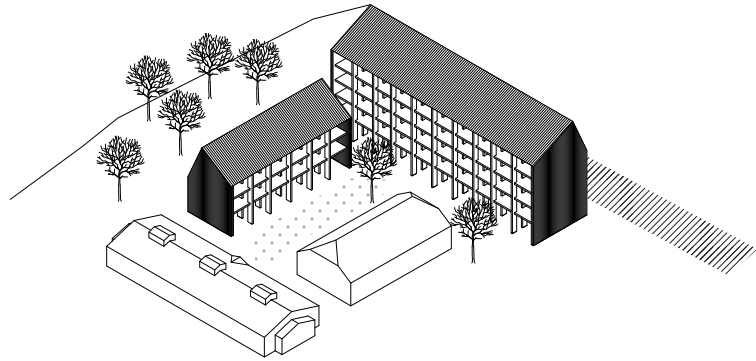
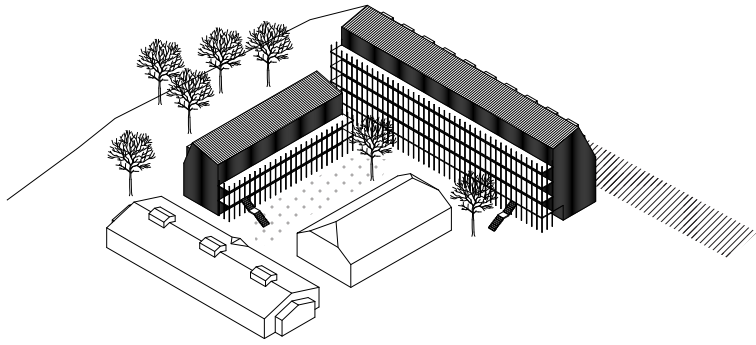



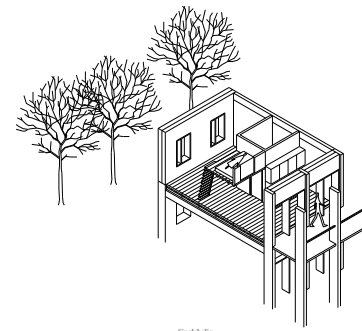
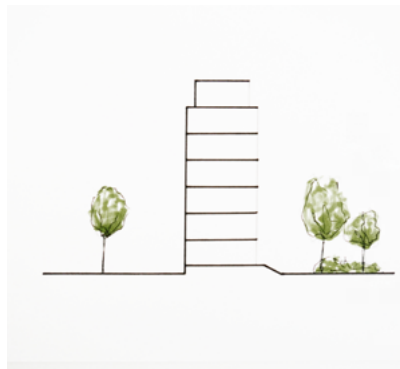
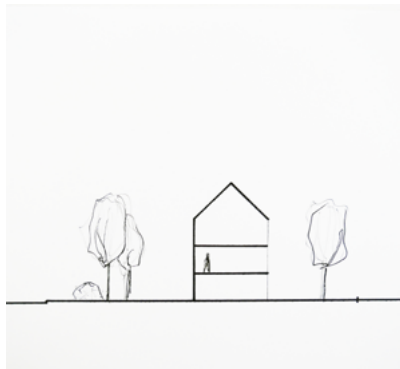

Singelbolig

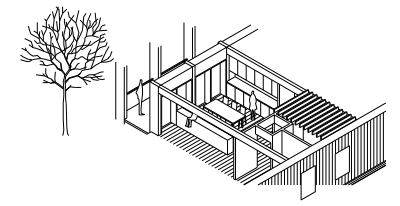

Fælleshøjskole

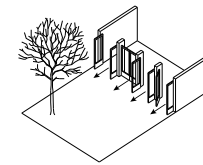

Sammenheng mellem side og bade

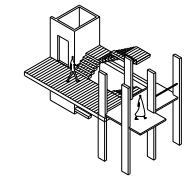

Aktivitetsfelt

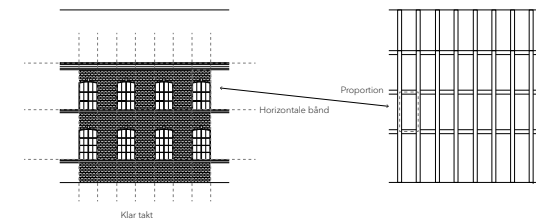

Takt og proportioner

Direkte udsyn.

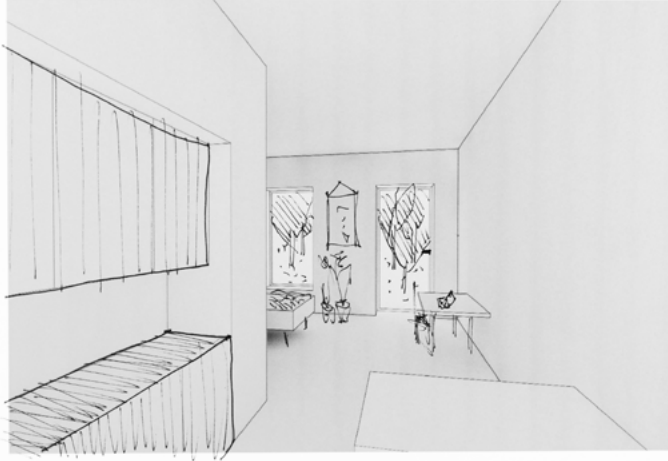

Etage  
Rundtårn

Kig ud i træerne

Dobbelthøjst fællesrum.



ophold på Altangang.

Direkte udsyn.

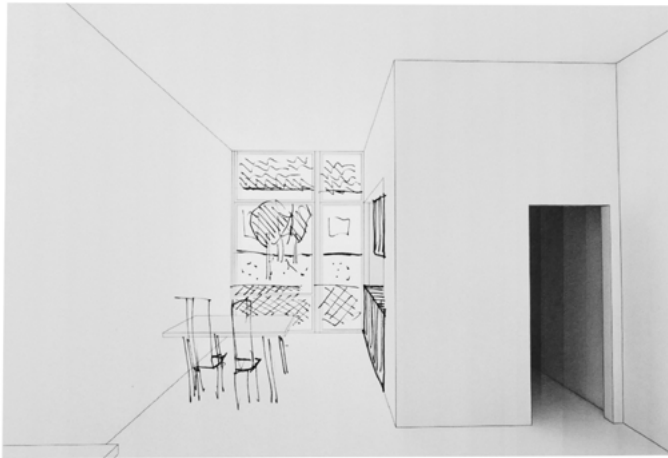

Etage  
Rundtårn

Direkte udgang til Altangang

Dobbelthøjst fællesrum.



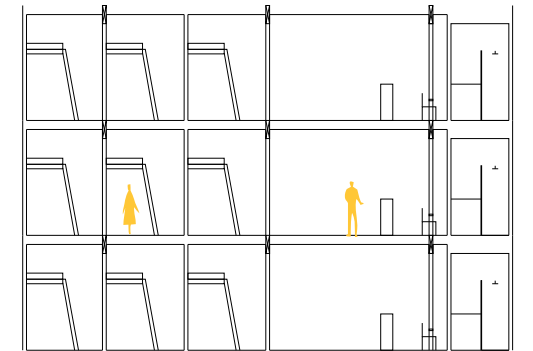
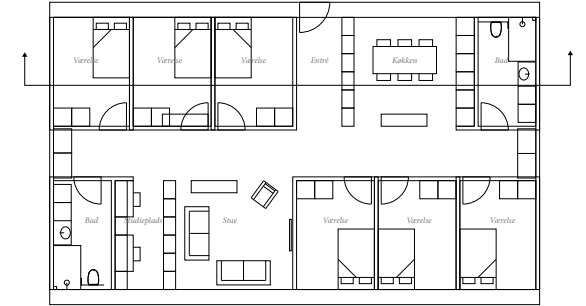
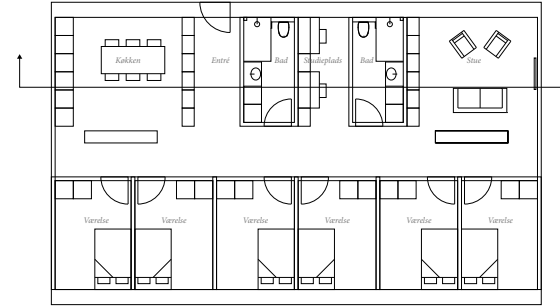
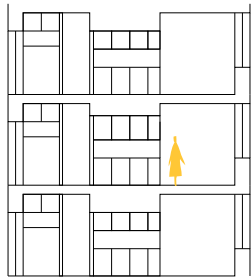
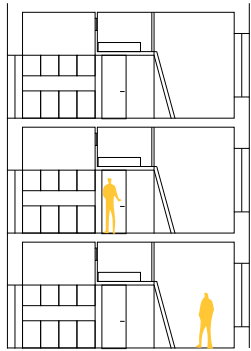
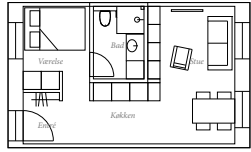
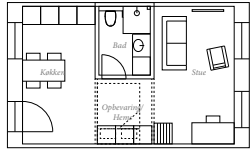

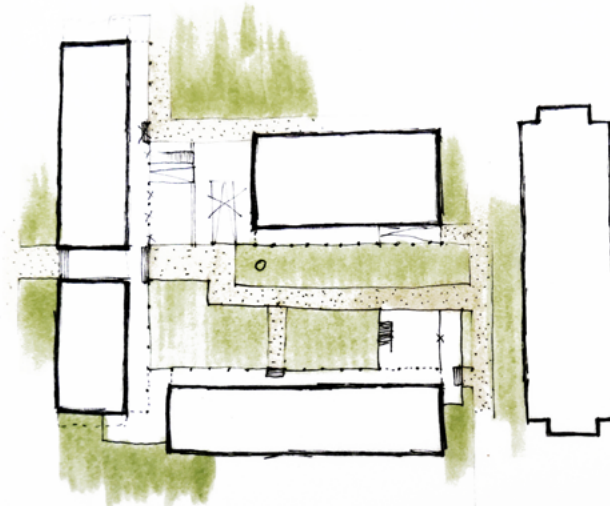

Fordeling af Boliger

