

DENIMVÆVERI I NKT-HUSET			AFGANG JANUAR
NKT-Huset, Priorparken 230, 2605 Brøndby, matr. 19i Brøndbyester			2016
SITUATIONSPLAN			
FREM TIDIGE FORHOLD			
TEGNINGSNUMMER	SKALA	FORMAT	SIGNATUR
A1.01	1:500	A2	17/12 2015
			JKB

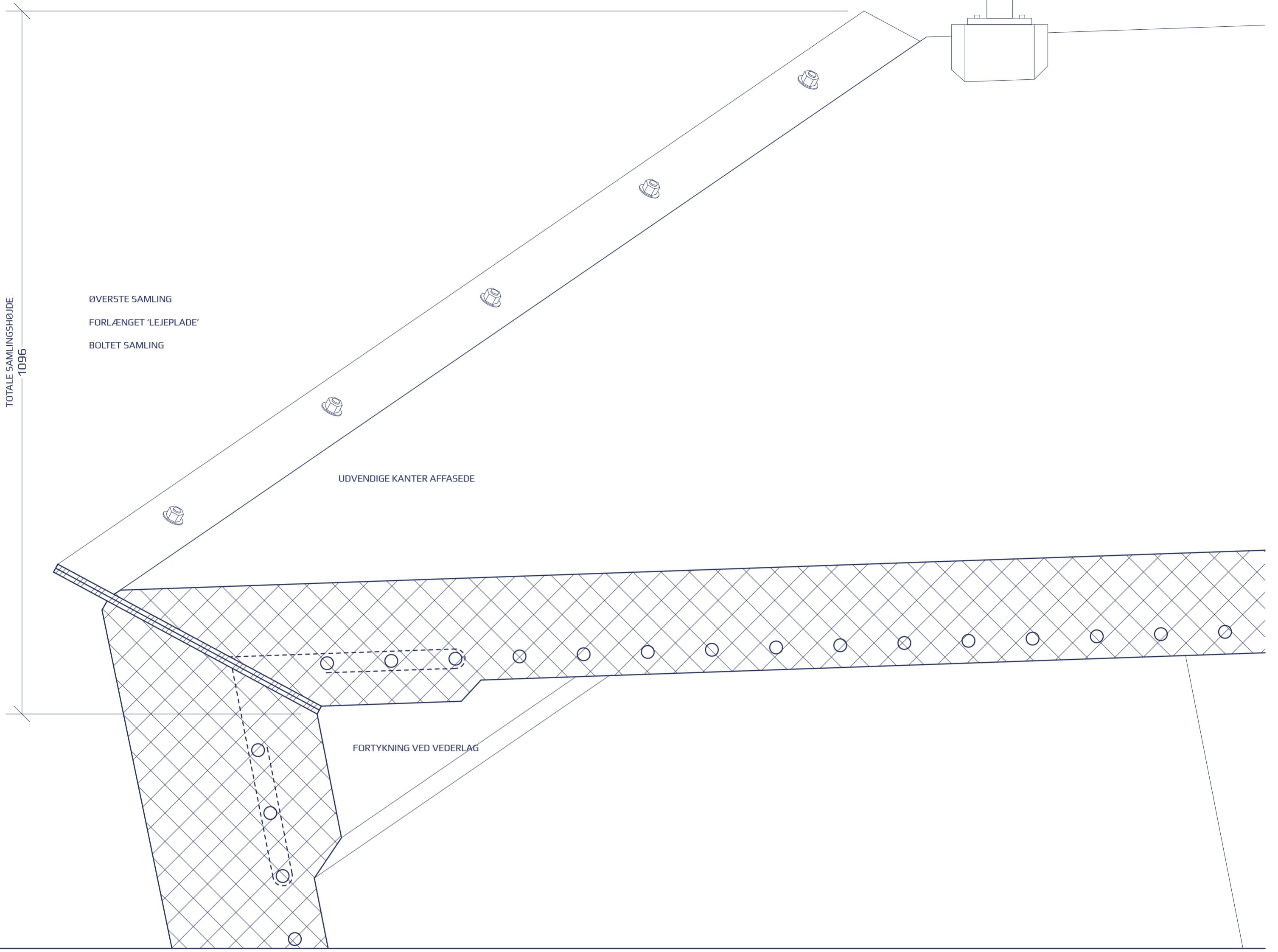
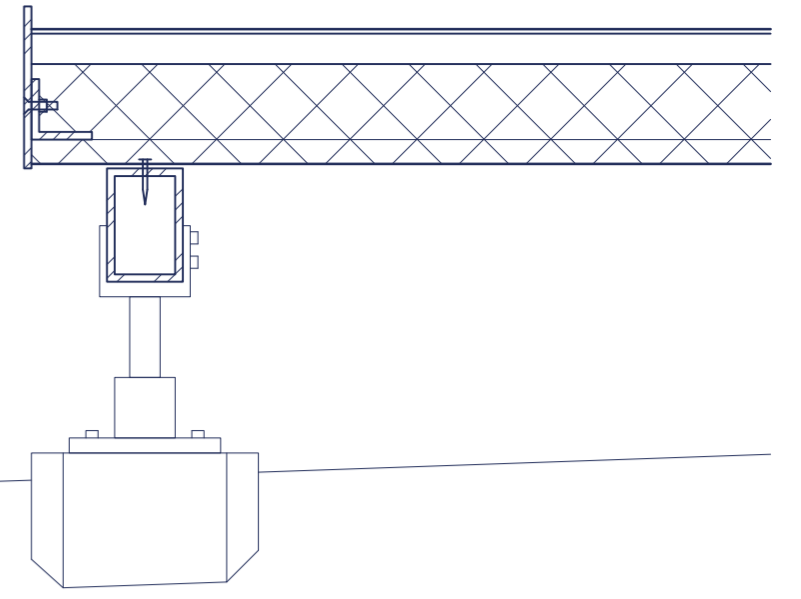

TOTALE SAMLINGSHØJDE
1096

ØVERSTE SAMLING
FORLÆNGET 'LEJEPLADE'
BOLTET SAMLING

UDVENDIGE KANTER AFFASEDE

FORTYKNING VED VEDERLAG

NEDERSTE SAMLING
FORLÆNGET 'LEJEPLADE'
BOLTET SAMLING

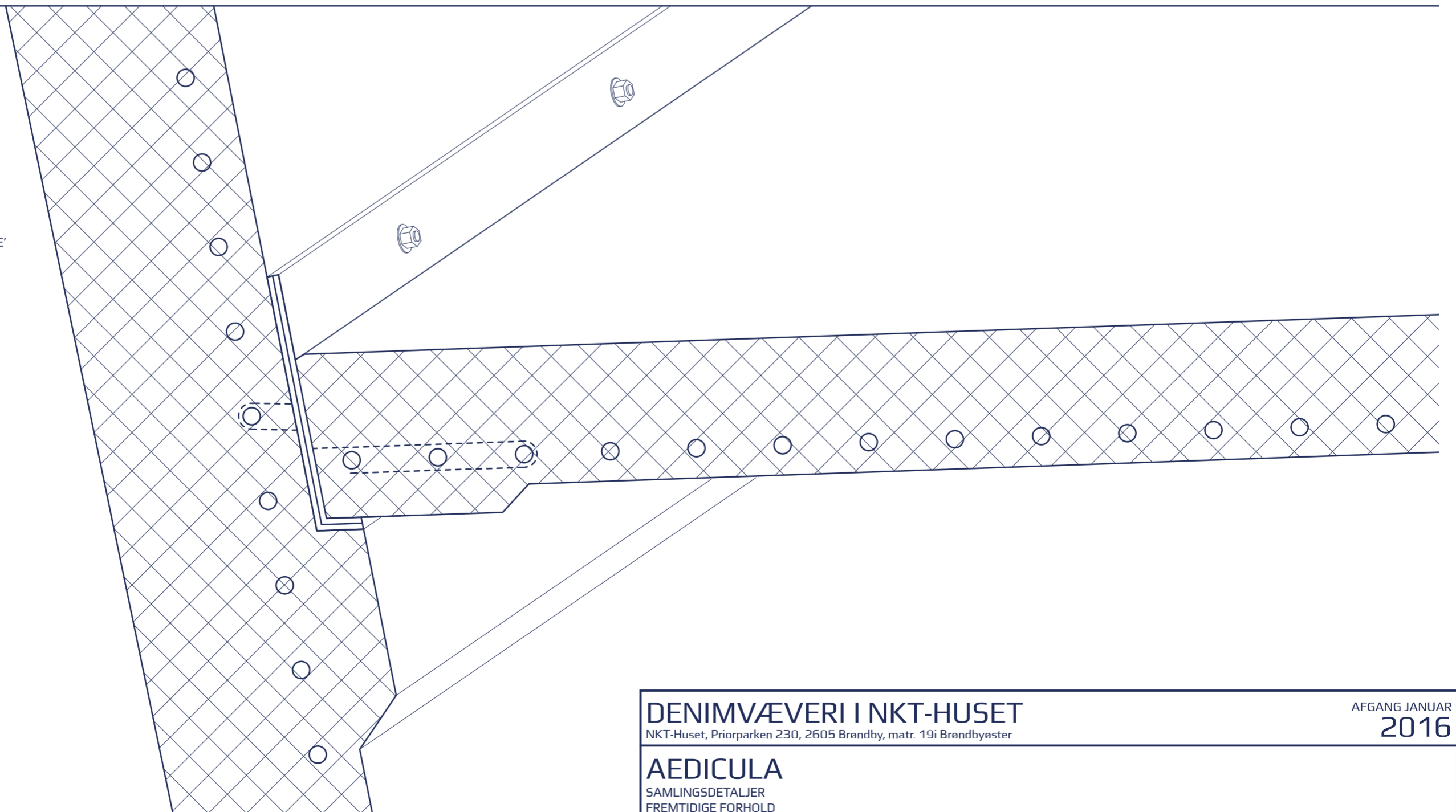

DENIMVÆVERI I NKT-HUSET

NKT-Huset, Priorparken 230, 2605 Brøndby, matr. 19i Brøndbyvester

AFGANG JANUAR
2016

AEDICULA
SAMLINGSDETALJER
FREMTIDIGE FORHOLD

TEGNINGSNUMMER	SKALA	FORMAT	SIGNATUR
A3.21	1:5	A2	17/12 2015 JKB

FARVNING

VÆVNING

FÆRDIGBEHANDLING

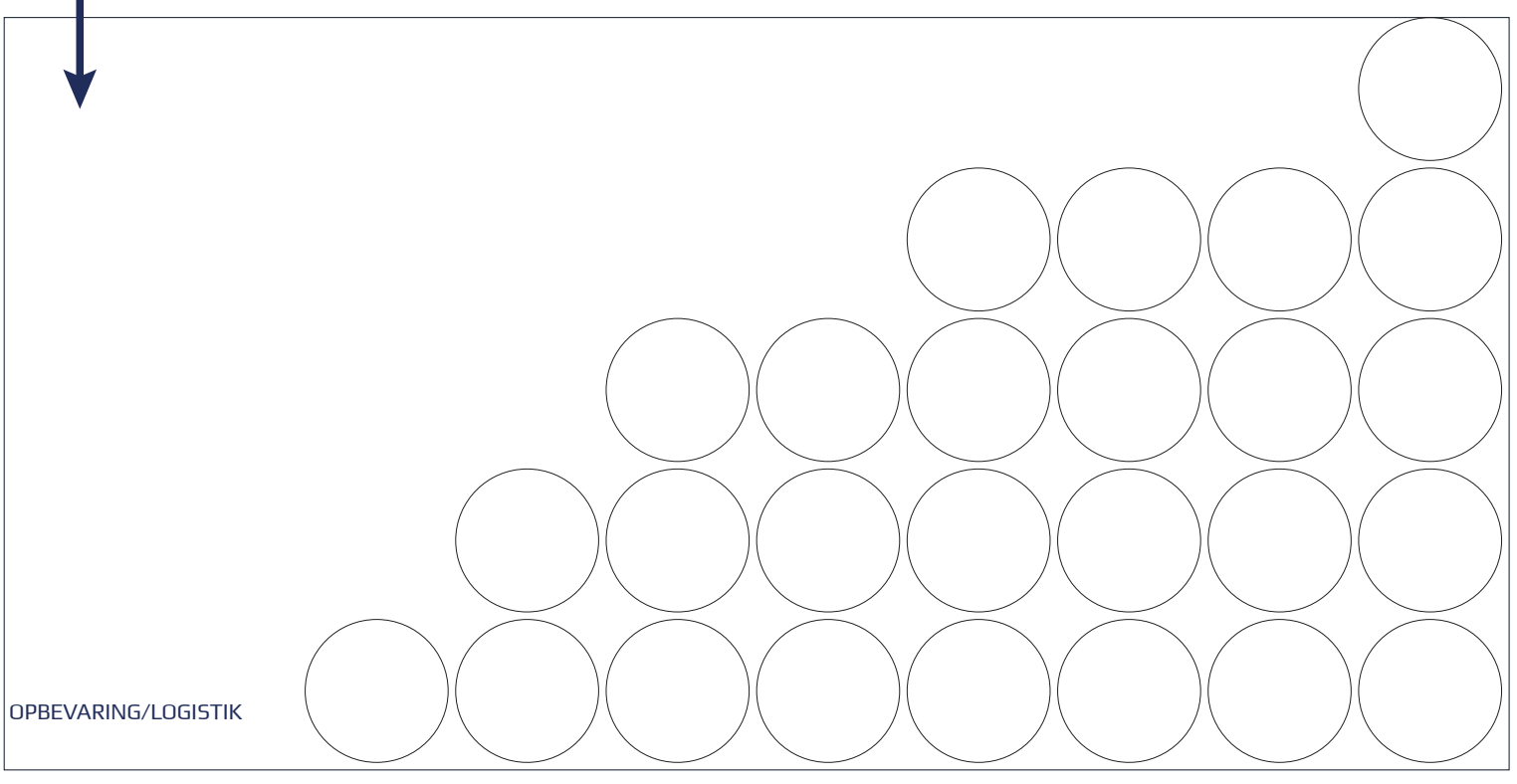


OPBEVARING/LOGISTIK

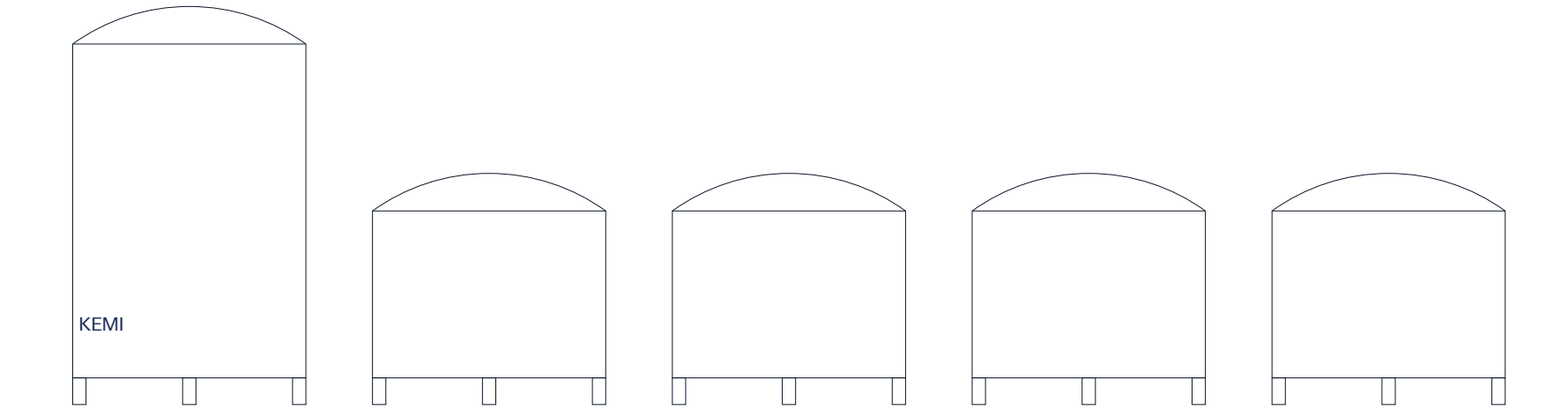

KEMI

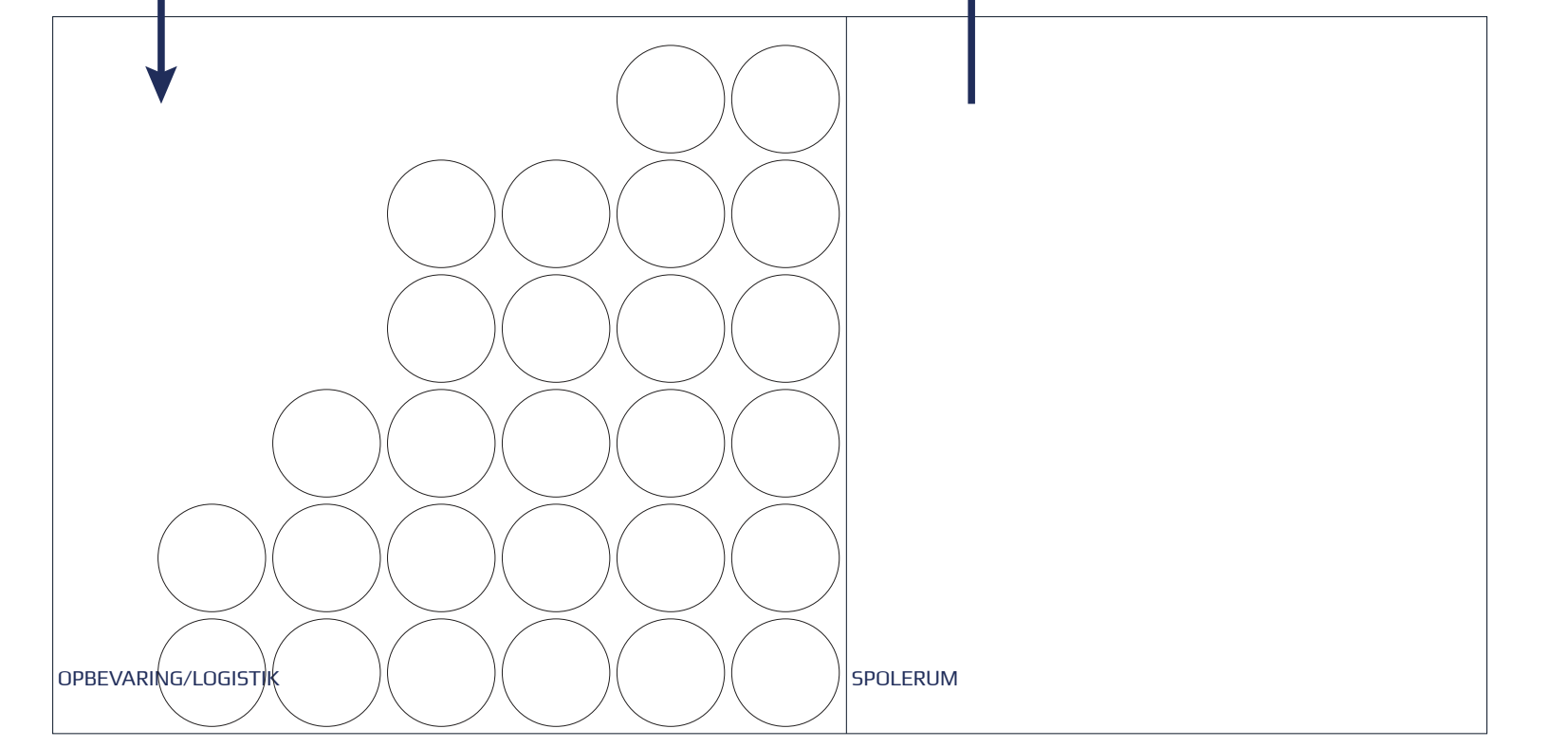

OPBEVARING/LOGISTIK

SPOLERUM

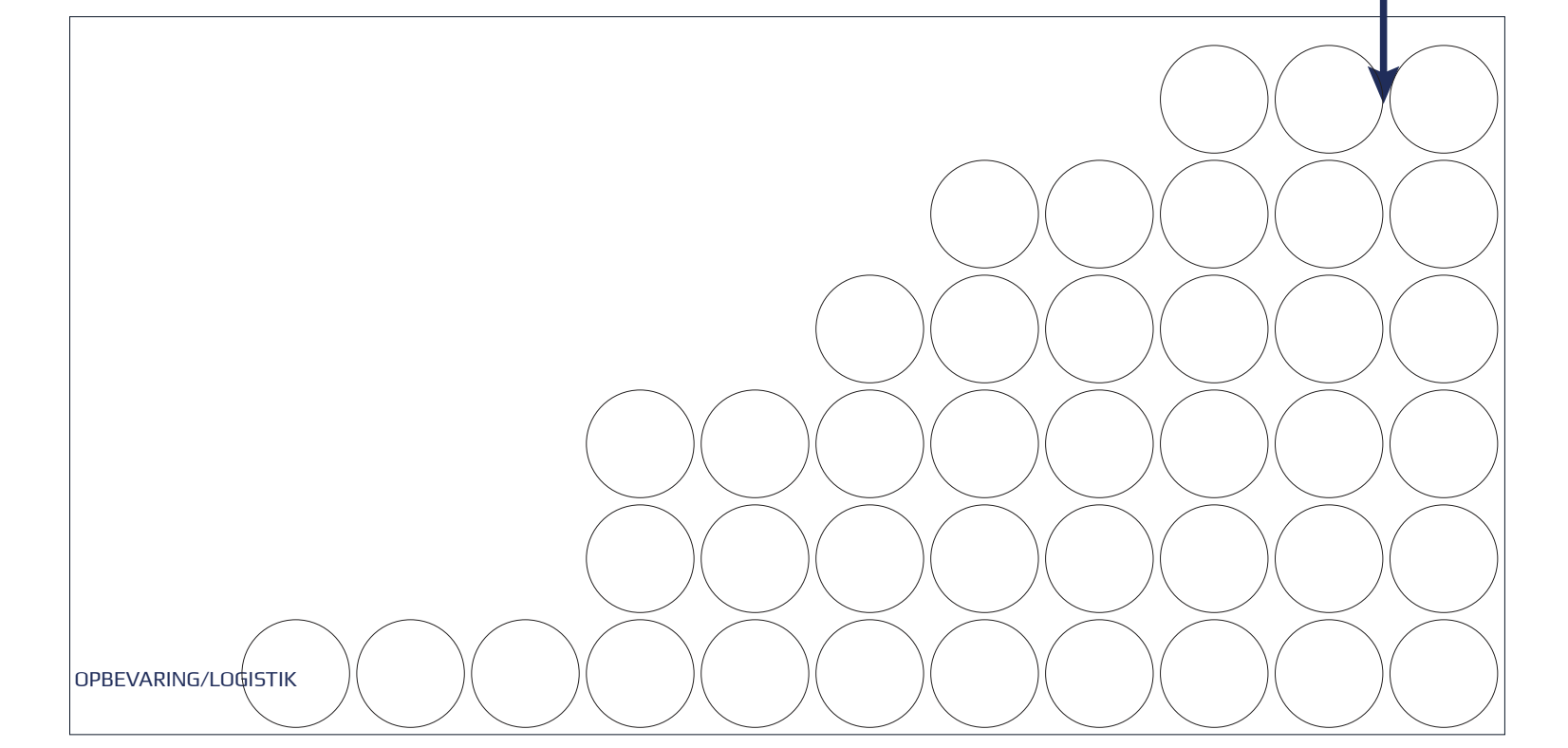

OPBEVARING/LOGISTIK

DENIMVÆVERI I NKT-HUSET			AFGANG JANUAR 2016
NKT-Huset, Prioparken 230, 2605 Brøndby, matr. 19i Brøndbyvester			
PRODUKTIONSDIAGRAM			
MASKINERI			
TEGNINGNUMMER	SKALA	FORMAT	SIGNATUR
A9.45	1:50	168 X 30	17/12 2015 JKB

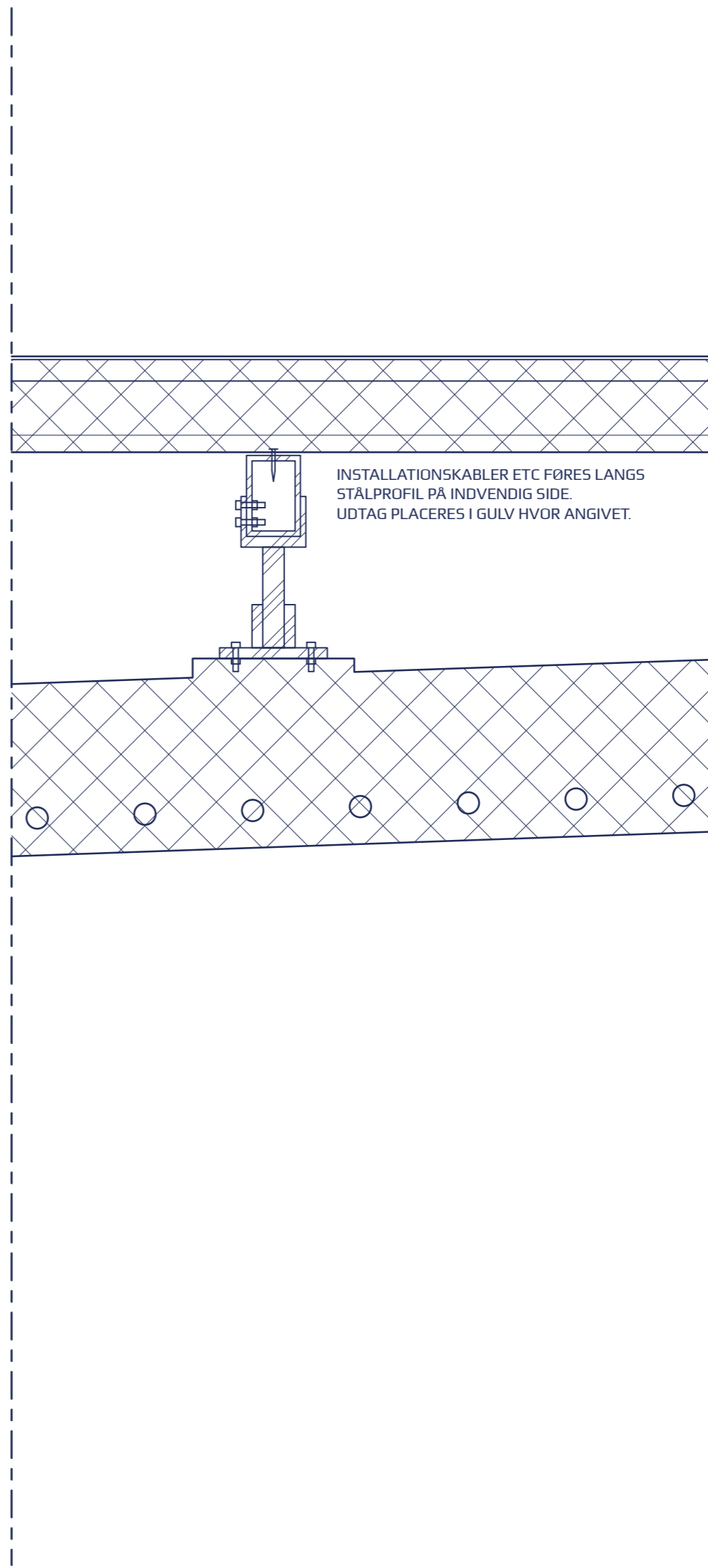
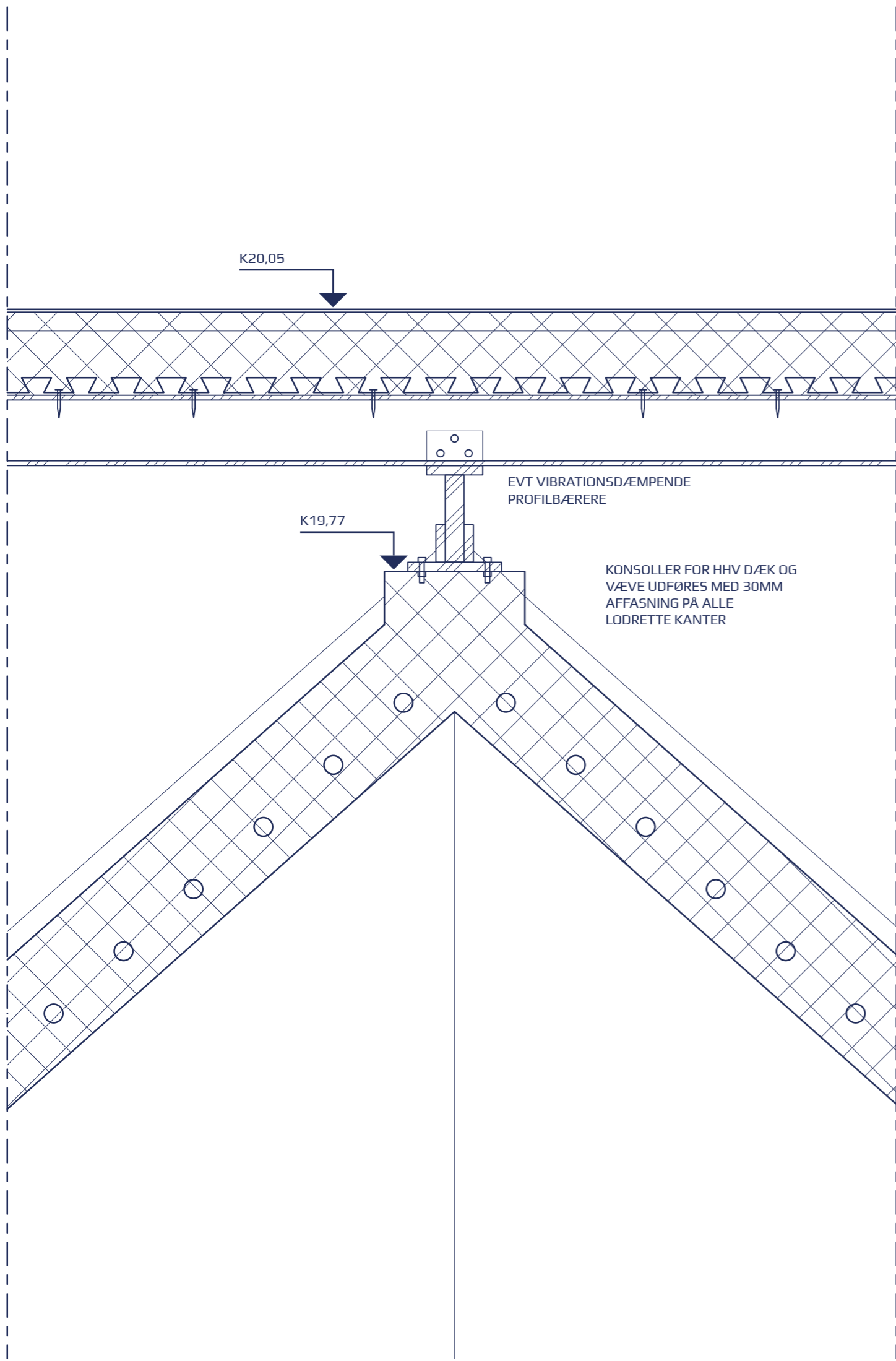

GULVOPBYGNING:
 FUGEFRIT EPOXYGULV: RAL 5022 - MØRK INDIGO
 20MM SLIDLAG/AFRETNING
 66MM BETON
 16MM SVALEHALEPLADER
 50X75MM STÅLPROFIL C-C 900MM
 STÅLBJÆLKEBÆRER
 BETONELEMENT

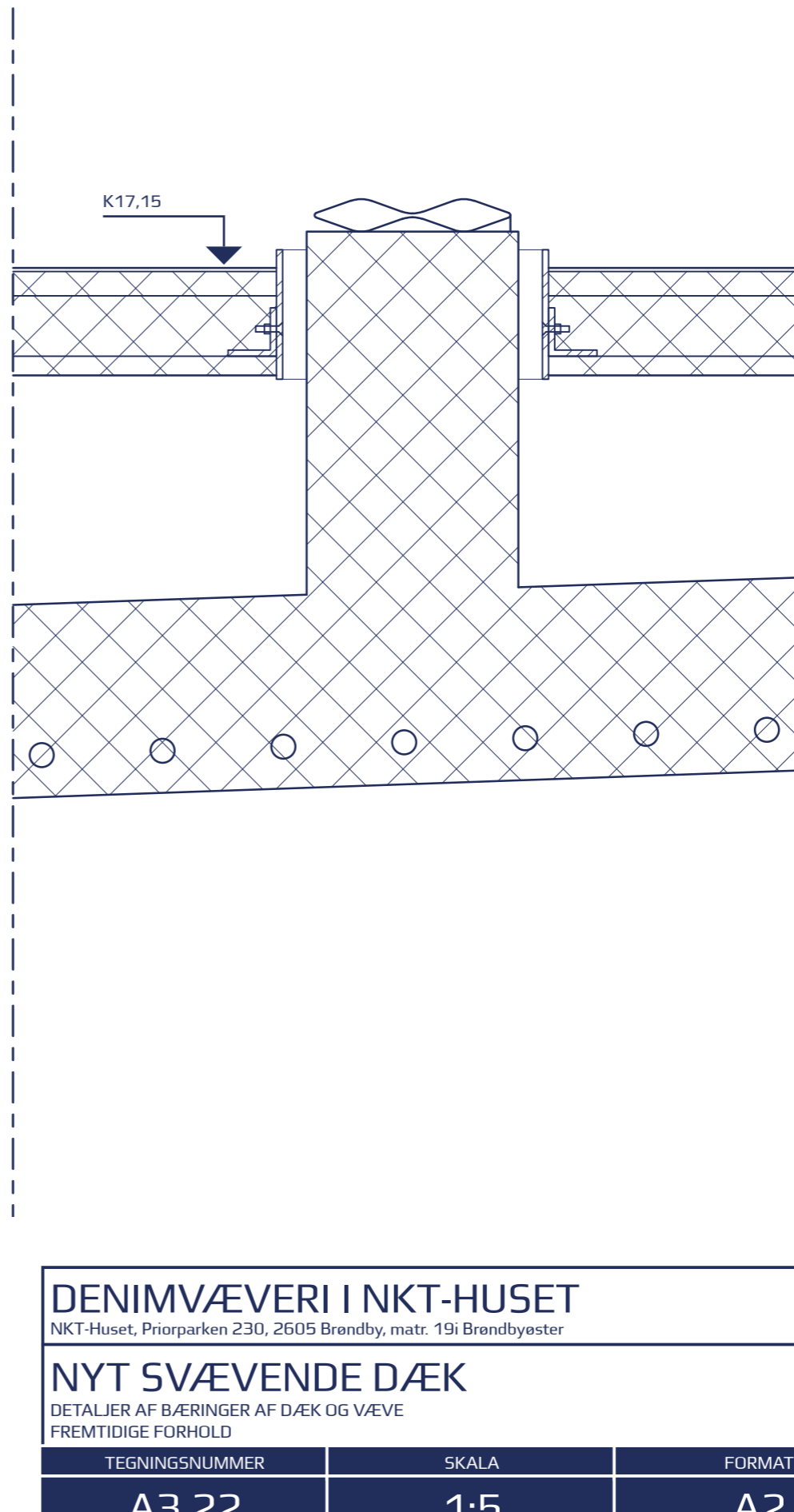
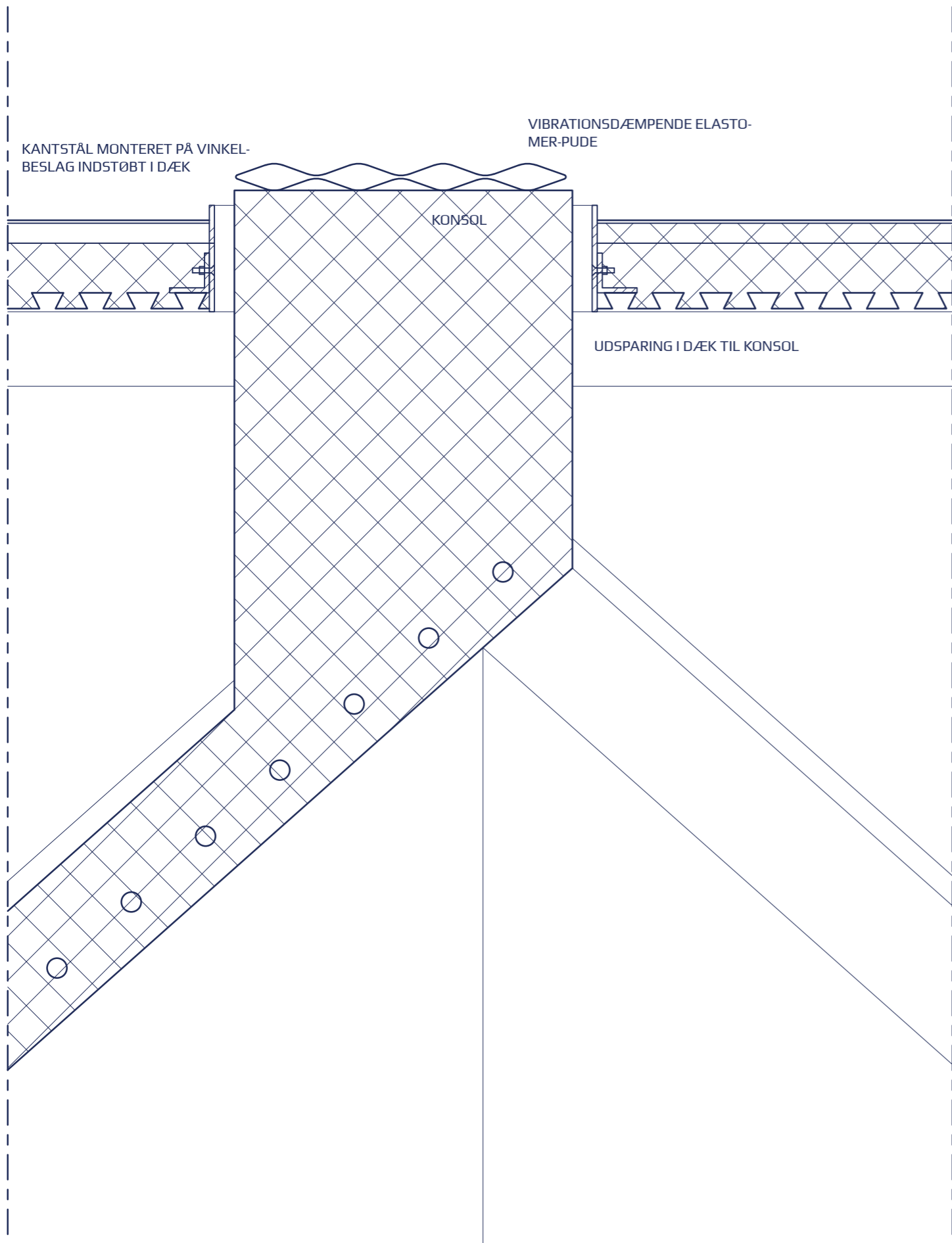

DENIMVÆVERI I NKT-HUSET

NKT-Huset, Priorparken 230, 2605 Brøndby, matr. 19i Brøndbyvester

AFGANG JANUAR
2016

NYT SVÆVENDE DÆK

DETALJER AF BÆRINGER AF DÆK OG VÆVE
 FREMTIDIGE FORHOLD

TEGNINGSNUMMER	SKALA	FORMAT	SIGNATUR
A3.22	1:5	A2	17/12 2015 JKB

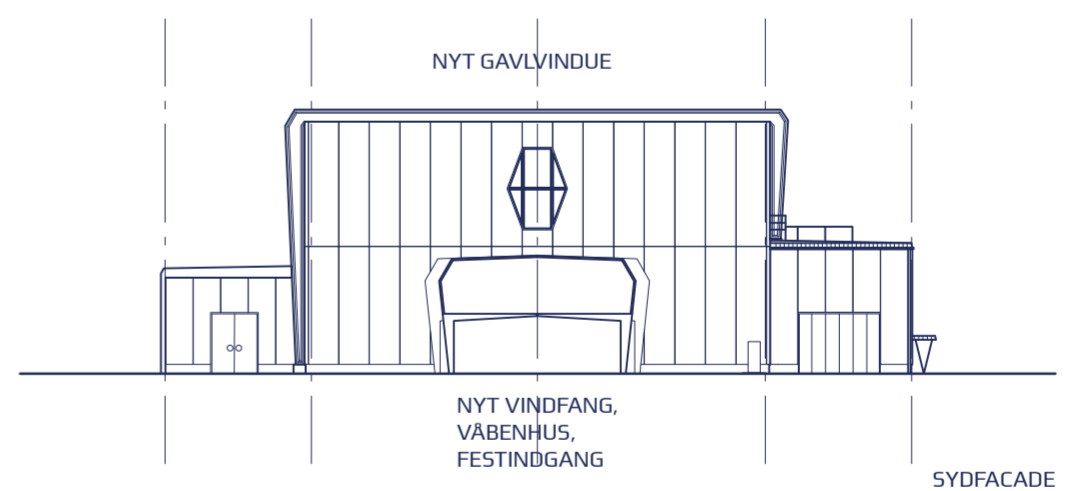
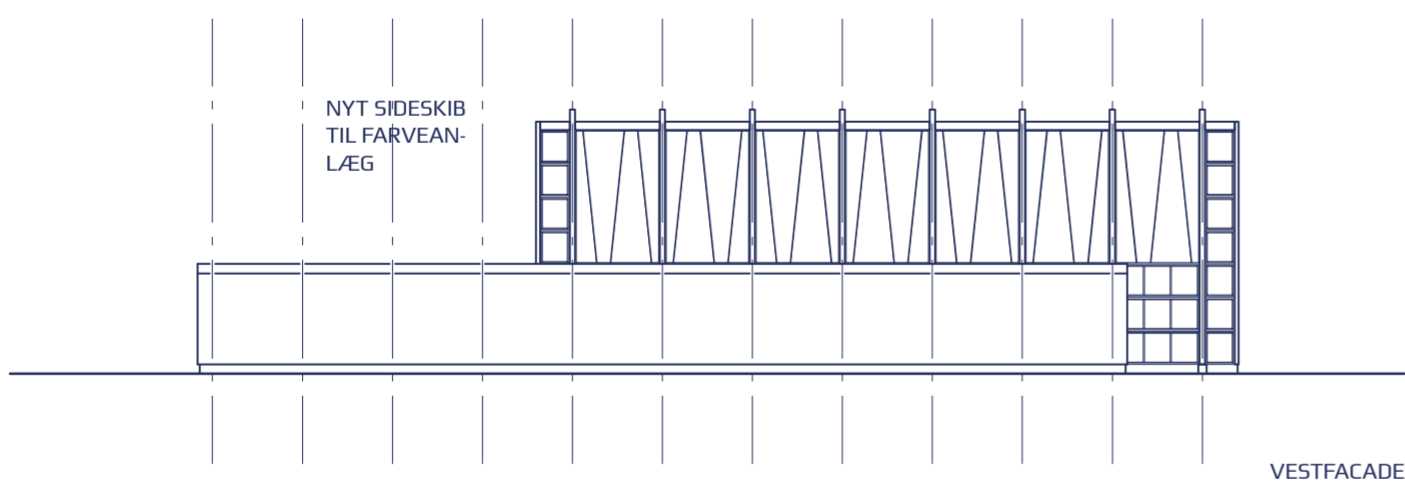
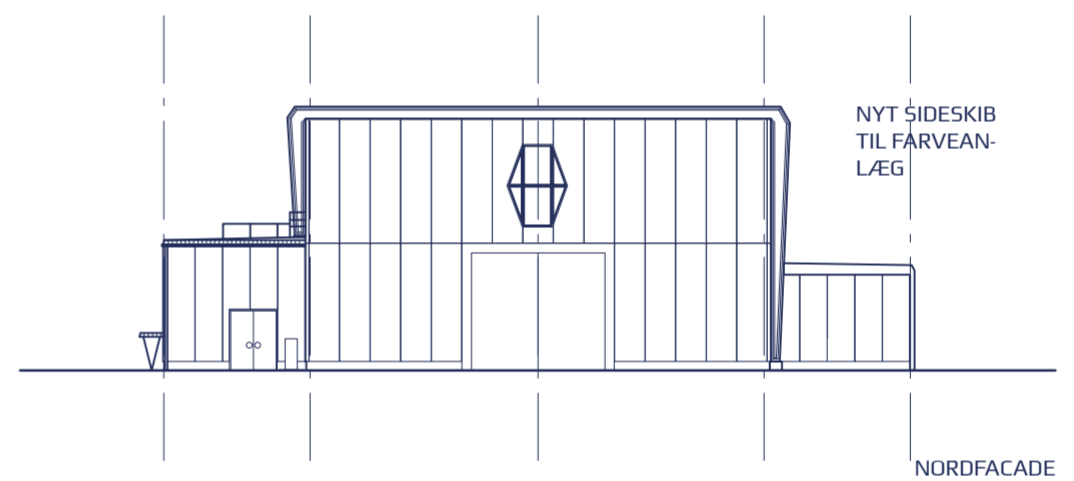
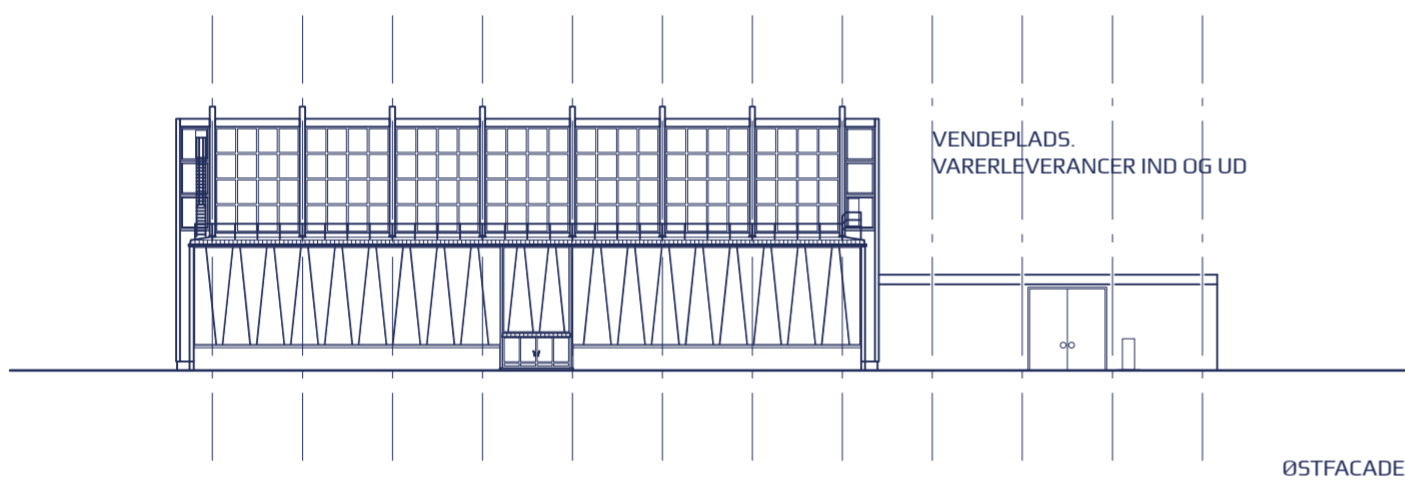
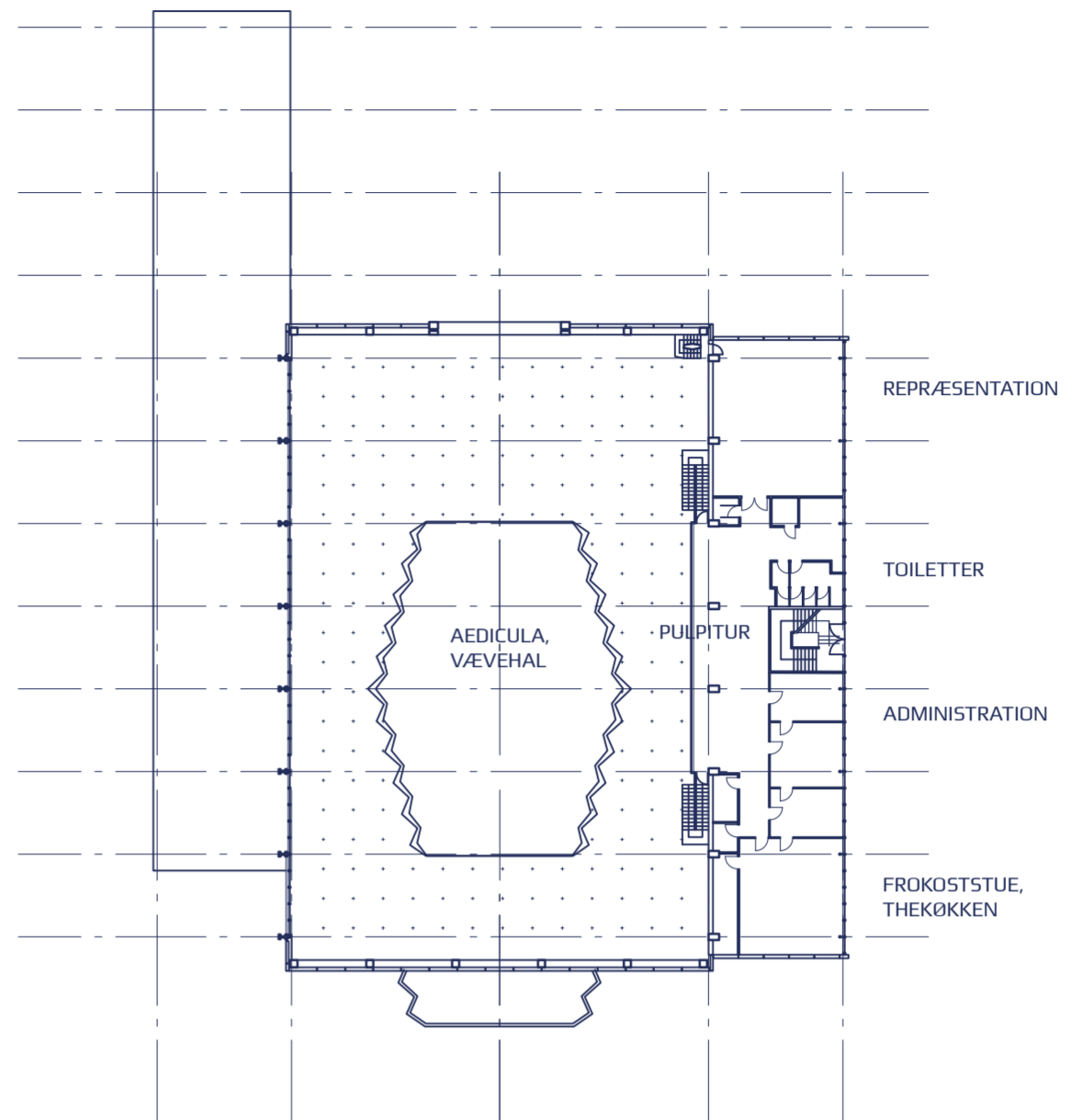
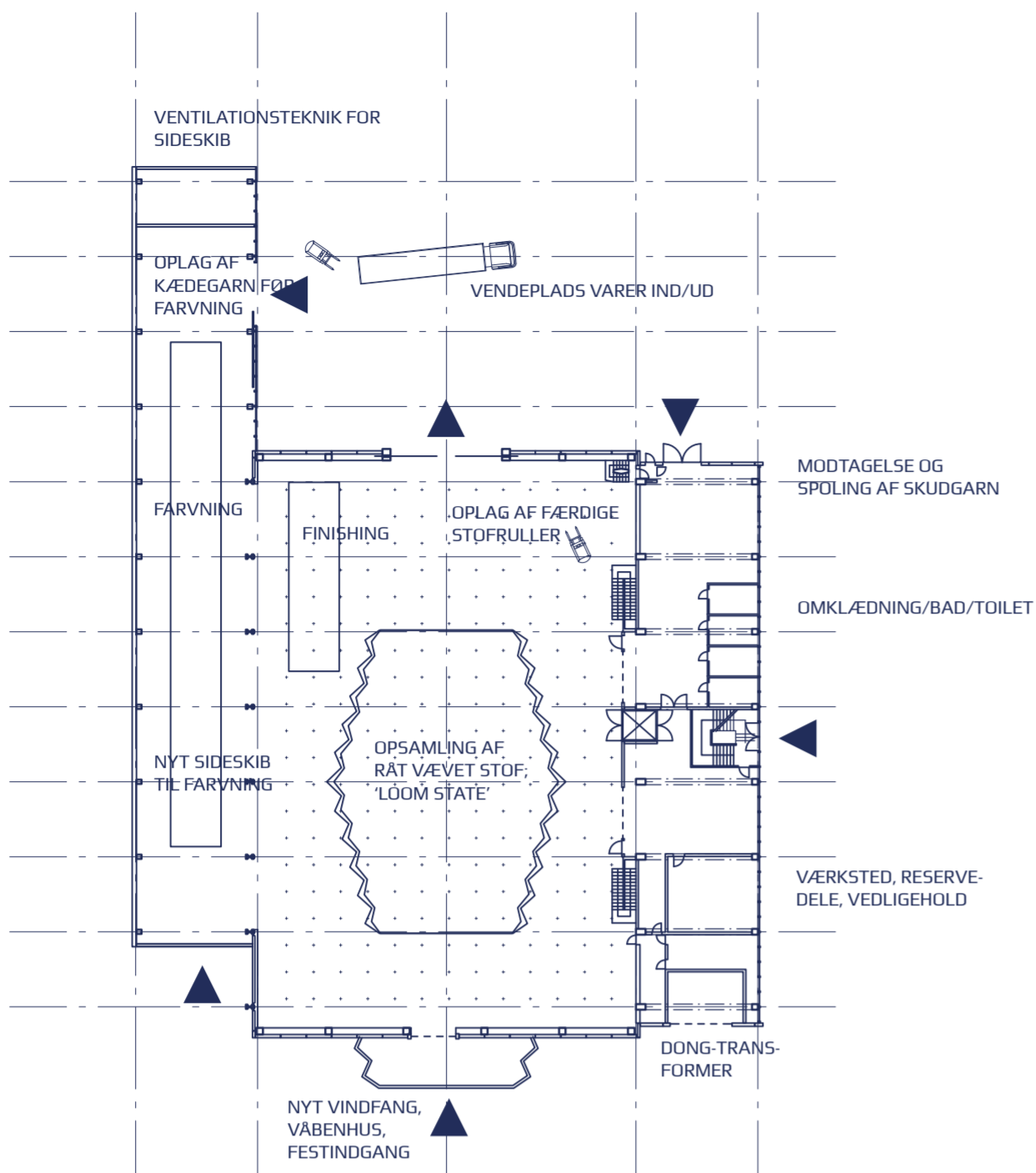

DENIMVÆVERI I NKT-HUSET			AFGANG JANUAR 2016
NKT-Huset, Priorparken 230, 2605 Brøndby, matr. 19i Brøndbyester			
OVERSIGT FREMtidigE FORHOLD			
TEGNINGSNUMMER	SKALA	FORMAT	SIGNATUR
A1.02	1:500	A2	17/12 2015 JKB

7

D

TRÆDEFEST ISOLERING MED TAGPAP

UDSPYR

RENDEJERN PÅBØRET
FORPLADENS OVERKANT

STÅLPROFIL FOR BÆRING AF SVALEHÅLEPLADER

DORNSAMLING

LEJEPLADE

BRUNELOXERET ZINKRENDE

UDSPYR PLACERES I HVER
MODULLINE
MÅL: 5950 MM C-C

20 MM DILETATIONSFUGE
MELLEM FACADEELEMENTER
FORPLADERNE UDFØRES AFFASEDE MOD
SAMLINGER

DENIMVÆVERI I NKT-HUSET

NKT-Huset, Priorparken 230, 2605 Brøndby, matr. 19i Brøndbyvester

AFGANG JANUAR
2016

TAGFOD NYT SIDESKIB

DETALJER
FREMTIDIGE FORHOLD

TEGNINGSNUMMER	SKALA	FORMAT	SIGNATUR
A3.23	1:5	A2	17/12 2015 JKB

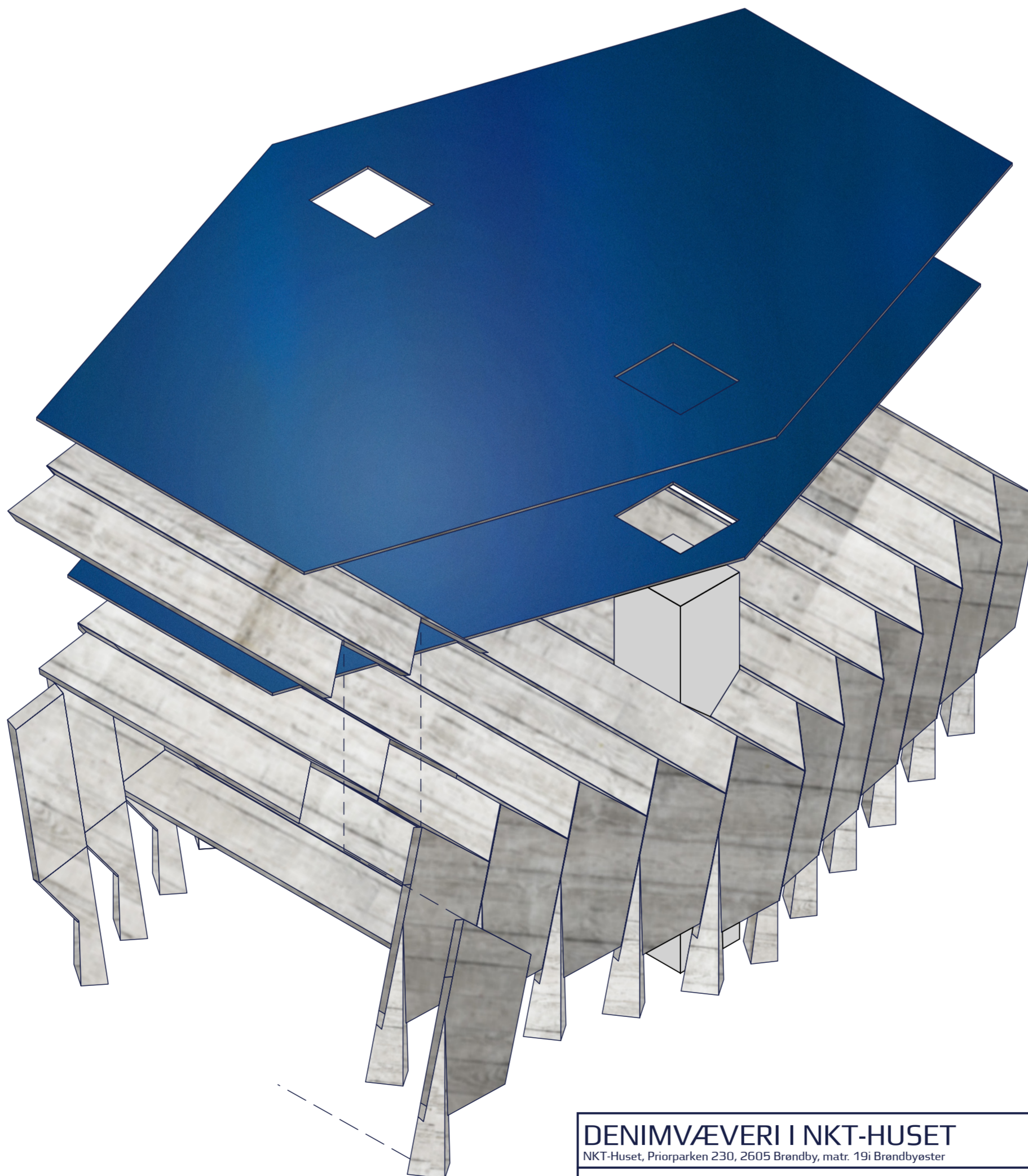
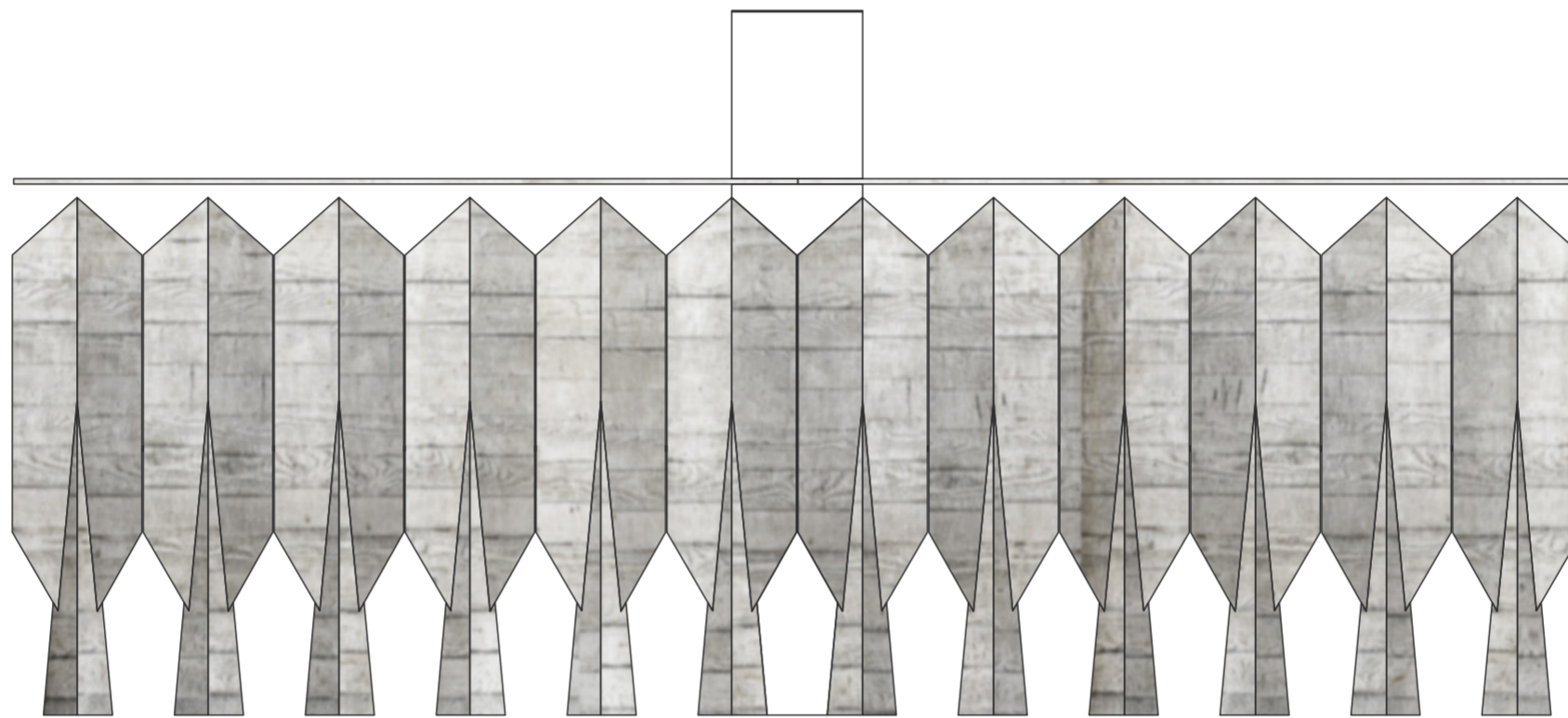
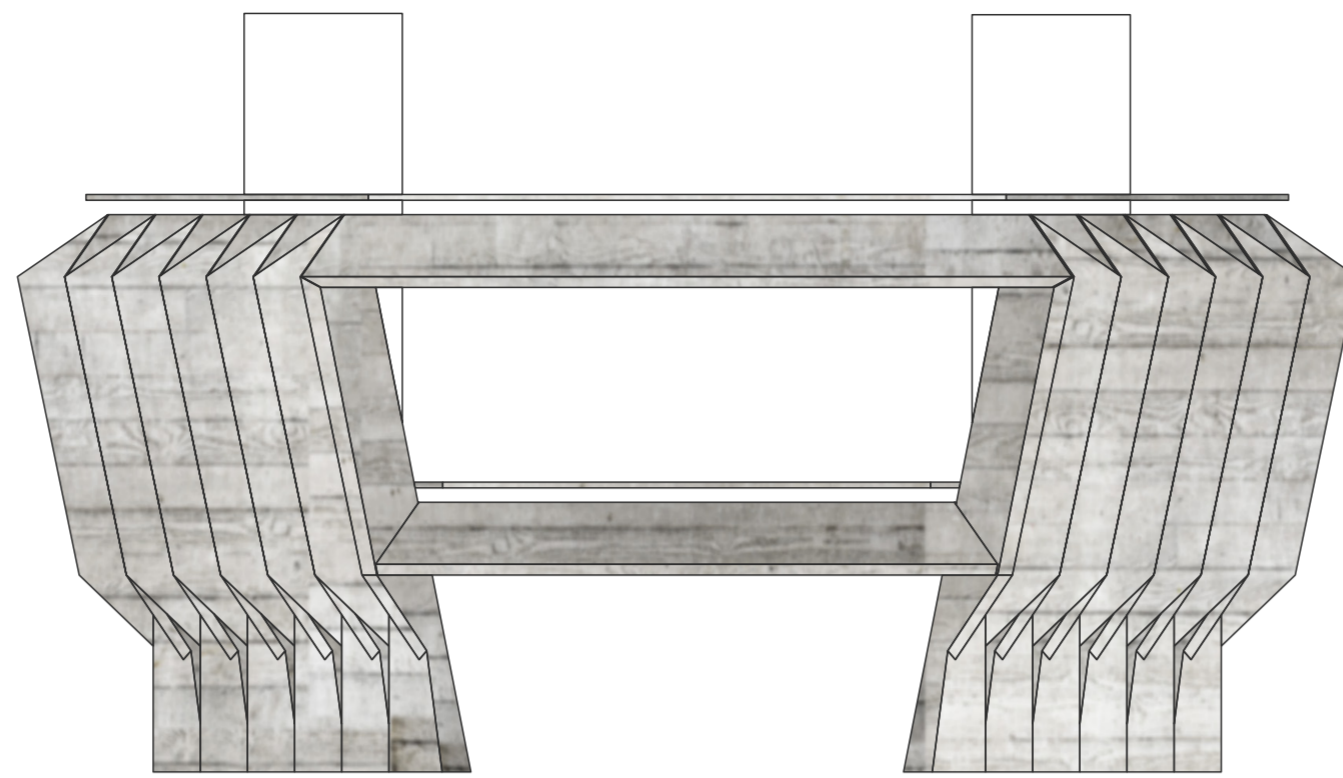

DENIMVÆVERI I NKT-HUSET
 NKT-Huset, Priorparken 230, 2605 Brøndby, matr. 19i Brøndbyester

AFGANG JANUAR
2016

AEDICULA
 FREMTIDIGE FORHOLD

TEGNINGSNUMMER	SKALA	FORMAT	SIGNATUR
A1.03	1:100	A2	17/12 2015 JKB



DENIMVÆVERI I NKT-HUSET

NKT-Huset, Priorparken 230, 2605 Brøndby, matr. 19i Brøndbyvester

AFGANG JANUAR
2016

NKT JEANS

VISUALISERING

TEGNINGSNUMMER	SKALA	FORMAT	SIGNATUR
A4.38	1:1	A2	17/12 2015
			JKB

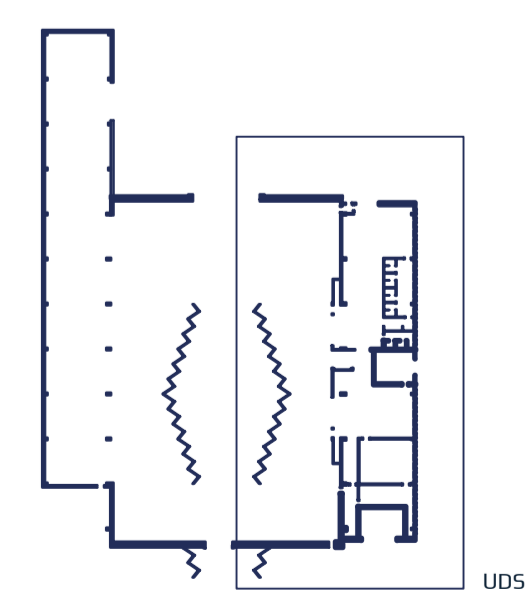
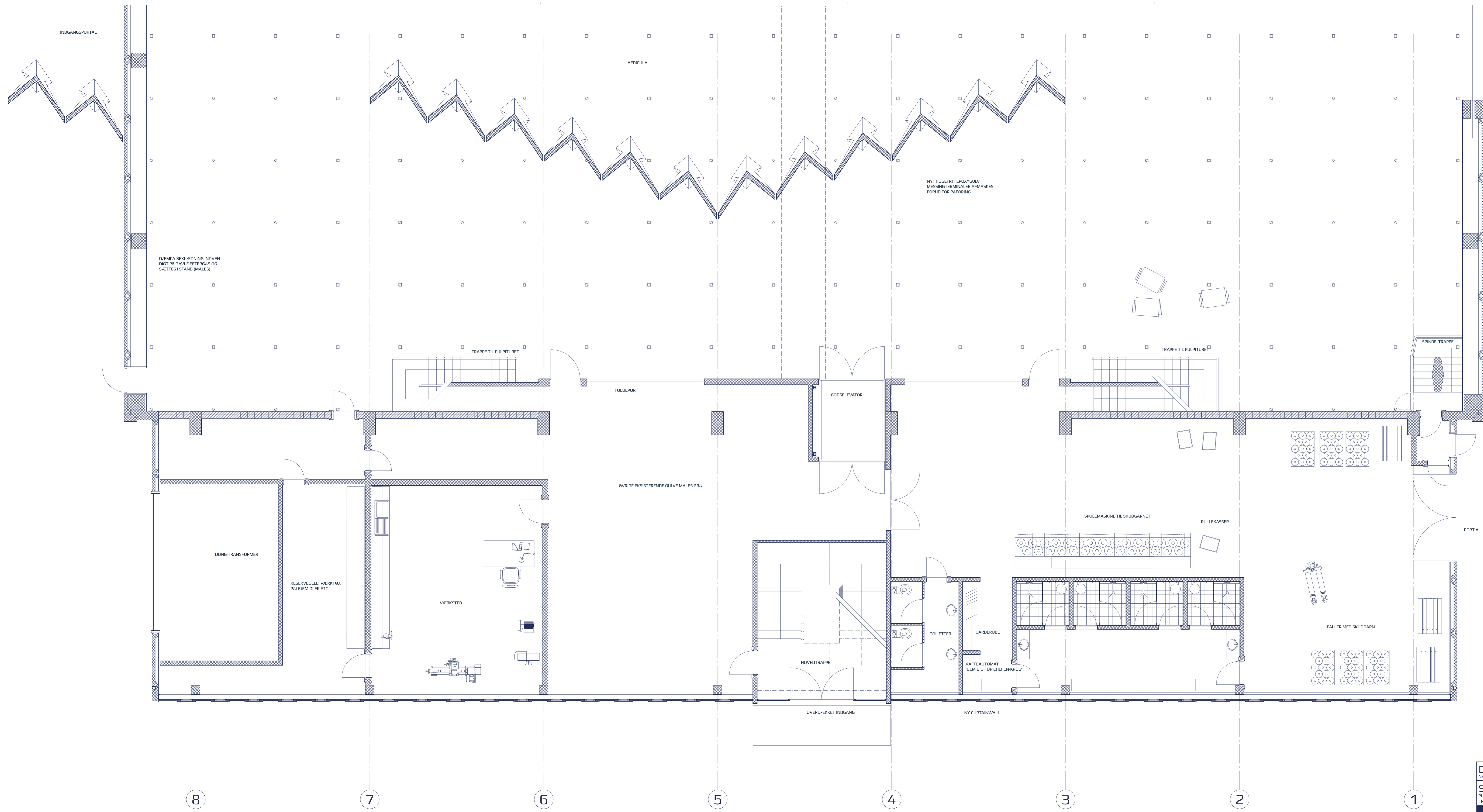

DENIMVÆVERI I NKT-HUSET		AFGANG JANUAR 2016	
NKT-Huset, Prinsesøen 2-30, 2500 Brøndby, tlf. 19, Brøndbycenter			
SIDEBYGNING			
PLANUDSNIT - HJÆLPBYGNINGENS STUEPLAN			
FREMTRUDE FORHOLD			
TEGNINGSNUMMER	SKALA	FORMAT	SIGNATUR
A2.11	1:50	126 x 60	JKB

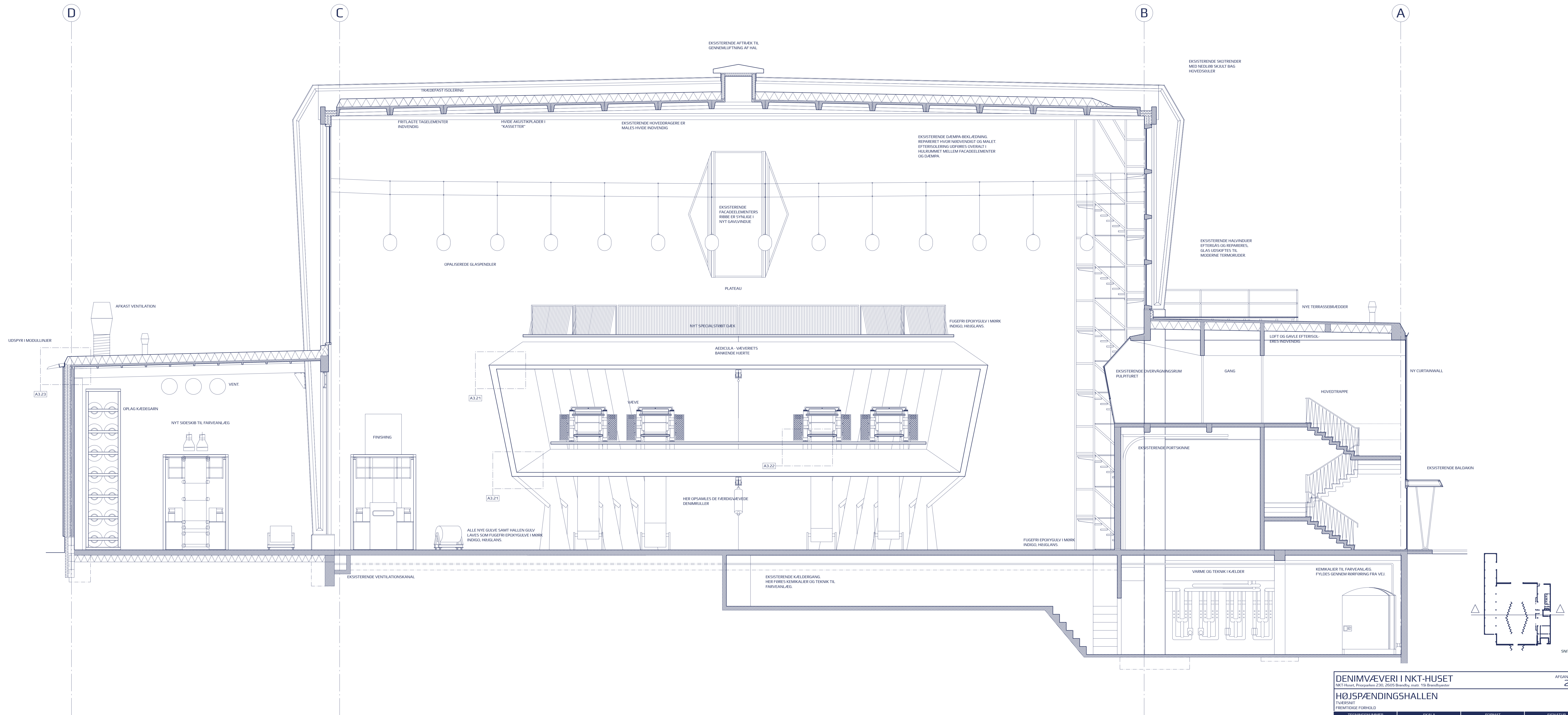

DENIMVÆVERI I NKT-HUSET <small>NKT-Huset, Priorparken 2.30, 2605 Brøndby, matr. 191 Brøndbyvester</small>				<small>AFGANG JANUAR</small> 2016
HØJSPÆNDINGSHALLEN <small>TVÆRSNIT</small> <small>FREMTHIDIGE FORHOLD</small>				
<small>TEGNINGSNUMMER</small> A2.12	<small>SKALA</small> 1:50	<small>FORMAT</small> 126 x 60	<small>SIGNATUR</small> <small>17/12.2015</small> <small>JKB</small>	

